

05176700 - LT-A VDI50 DIN-22 L-R H140 BA

Type	LT-A Tool holder angle 90°
Mounting	VDI 50
Tool output	Shell-Mill DIN138 22
Coolant	External coolant
Direction of rotation	r1 ↻ r2 ↻
Max speed [rpm]	6000
Max torque [Nm]	80
Ratio	1:1
H [mm]	140
H1 [mm]	38
Accessories	N.A.
Notes	N.A.
Mounting tips	Not suitable for every application, please check

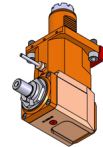

ATTENZIONE: VERIFICARE L'ORIENTAMENTO DELLA DENTATURA VDI

Always check live tool dimensions on the turret

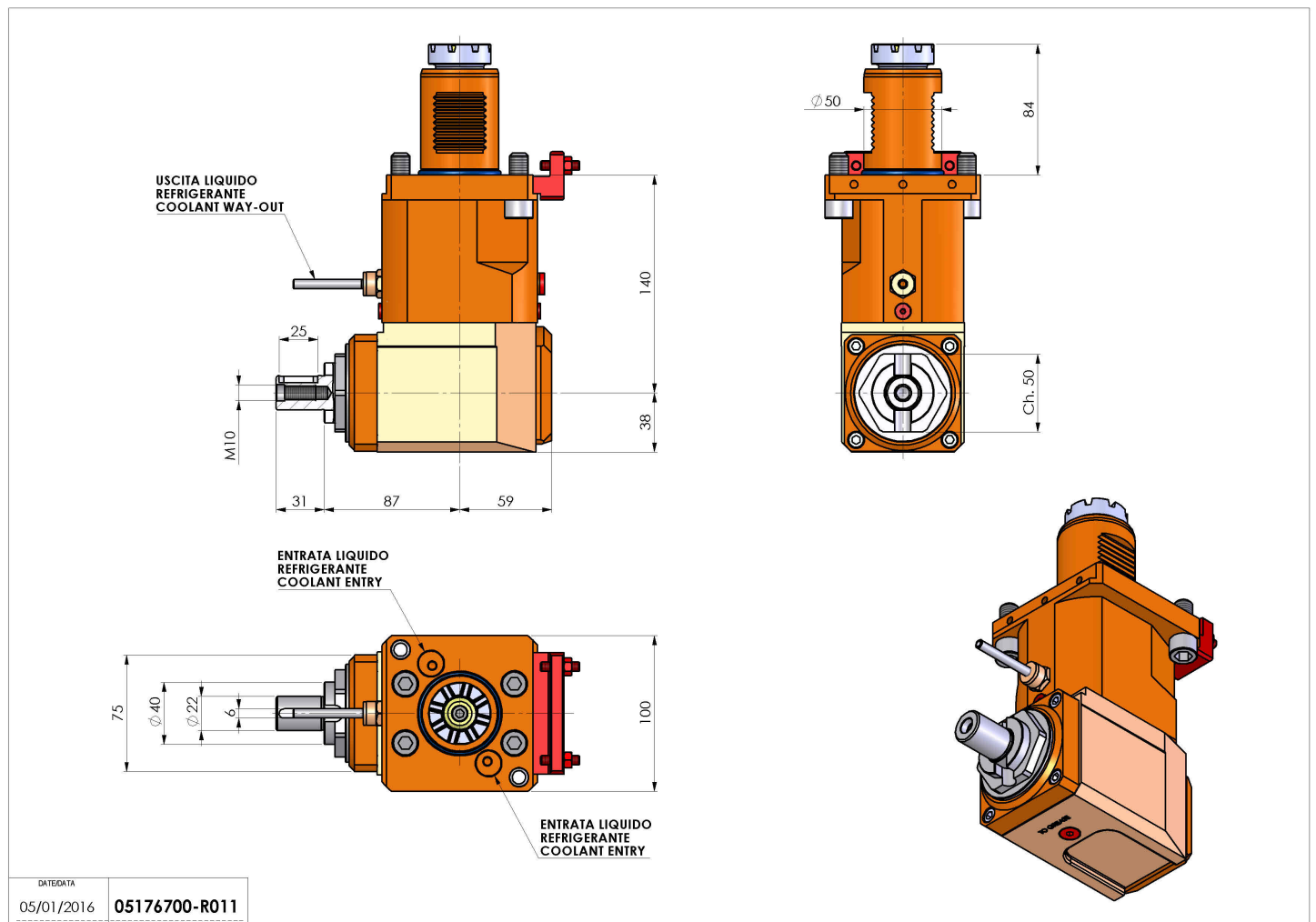

Subject to technical changes