

05175600 - LT-A VDI50 ER40-F L-R H105 BA

Type	LT-A Tool holder angle 90°
Mounting	VDI 50
Tool output	Collet nut ER 40 F - internal nut
Coolant	External coolant
Direction of rotation	r1 ↻ r2 ↻
Max speed [rpm]	6000
Max torque [Nm]	80
Ratio	1:1
H [mm]	105
H1 [mm]	43
Accessories	N.A.
Notes	N.A.
Mounting tips	Not suitable for every application, please check

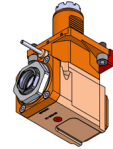

ATTENZIONE: VERIFICARE L'ORIENTAMENTO DELLA DENTATURA VDI

Always check live tool dimensions on the turret

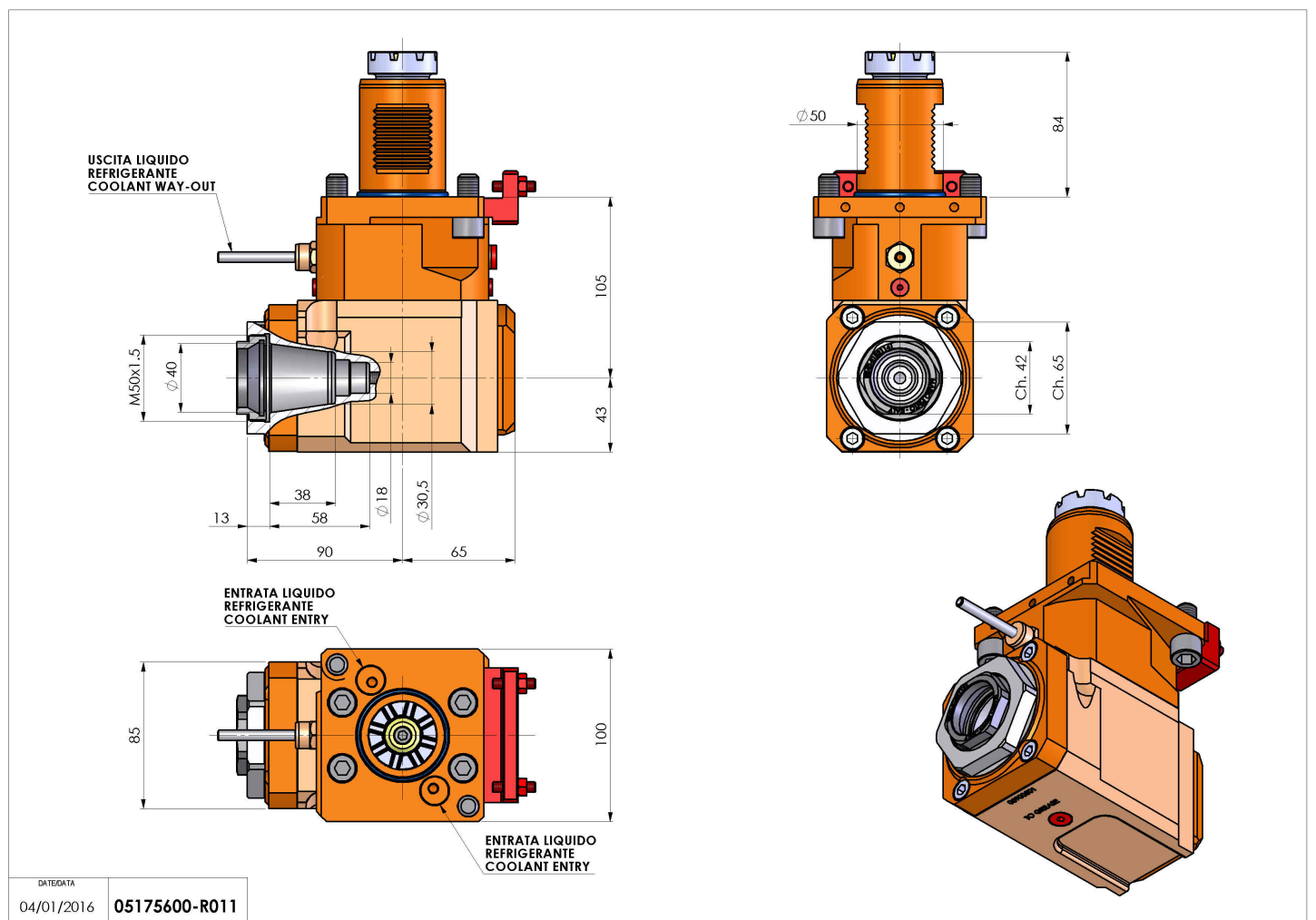

DATE/DATE
04/01/2016 **05175600-R011**

Subject to technical changes