

05157300 - LT-A D55 ER32F L-R H125 MU

Type	LT-A Tool holder angle 90°
Mounting	CYLINDRICAL SHANK 55
Tool output	Collet nut ER 32 F - internal nut
Coolant	External coolant
Direction of rotation	r1 ↻ r2 ↻
Max speed [rpm]	6000
Max torque [Nm]	63
Ratio	1:1
H [mm]	125
H1 [mm]	38
Accessories	N.A.
Notes	N.A.
Mounting tips	Not suitable for every application, please check

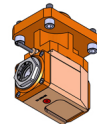

Always check live tool dimensions on the turret

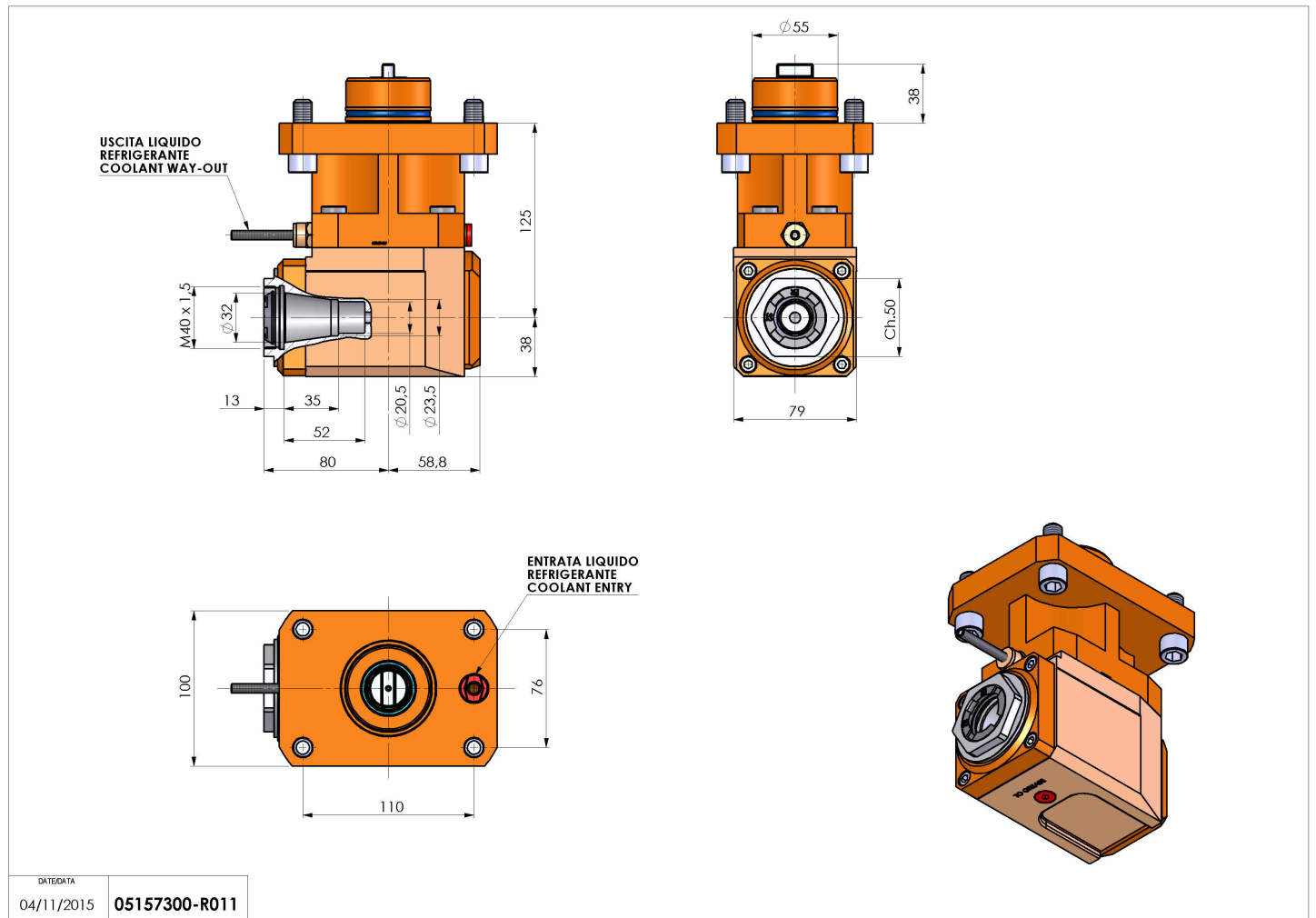

DATE/DATE 04/11/2015 05157300-R011

Subject to technical changes