

05132600 - LT-T VDI40 ER16F H63-132

Type	LT-T Tool holder tiltable
Mounting	VDI 40
Tool output	Collet nut ER 16 F - internal nut
Coolant	External coolant
Direction of rotation	r1 ↻ r2 ↻
Max speed [rpm]	6000
Max torque [Nm]	10
Ratio	1:1
H [mm]	63-132
Accessories	N.A.
Notes	N.A.
Mounting tips	Not suitable for every application, please check

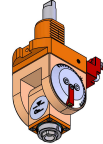

ATTENZIONE: VERIFICARE L'ORIENTAMENTO DELLA DENTATURA VDI

Always check live tool dimensions on the turret

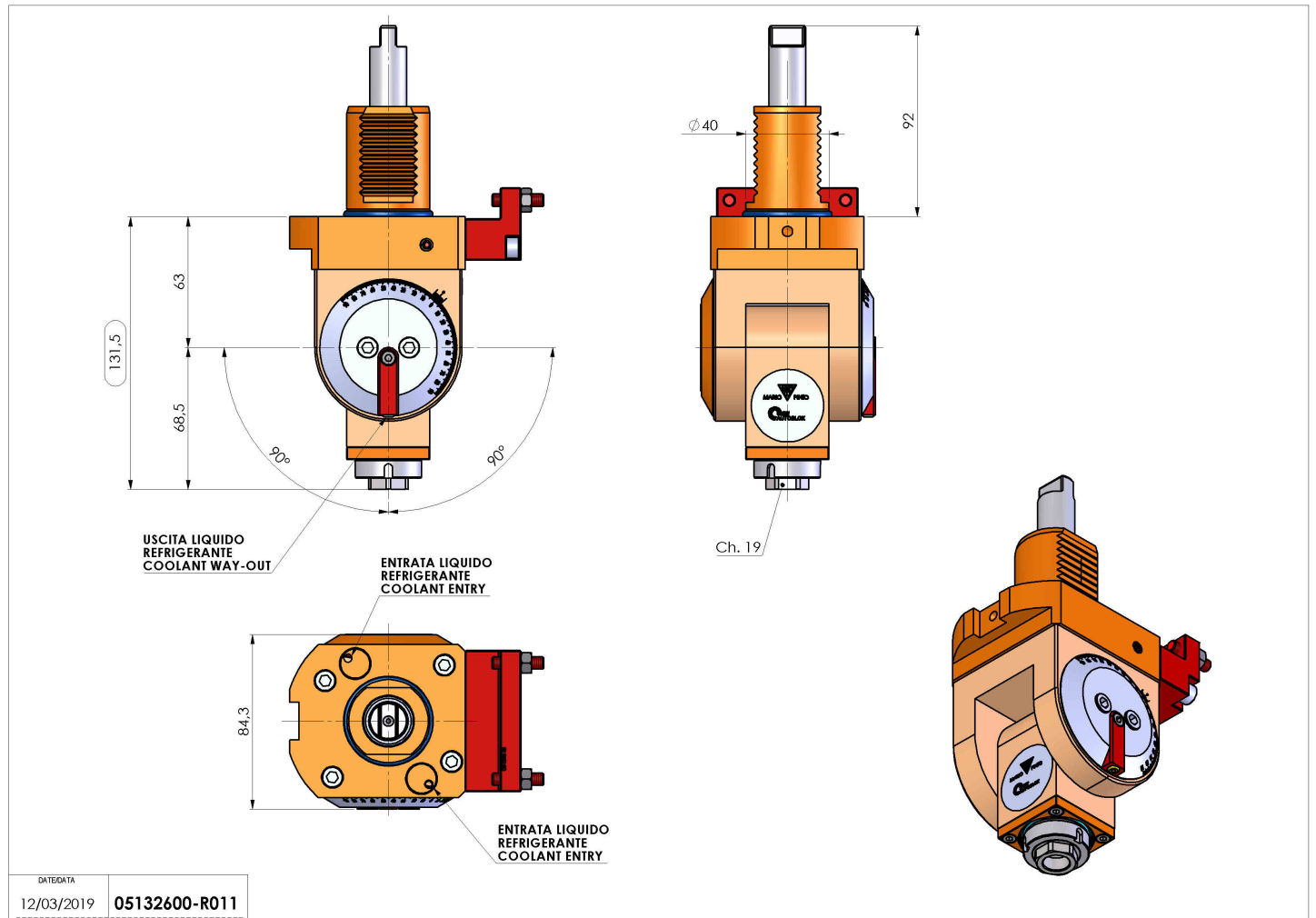

Subject to technical changes