



05114600 - LT-A VDI40 ER32F H75 130 HA

Type	LT-A Tool holder angle 90°
Mounting	VDI 40
Tool output	Collet nut ER 32 F - internal nut
Coolant	External coolant
Direction of rotation	r1  r2 
Max speed [rpm]	6000
Max torque [Nm]	63
Ratio	1:1
H [mm]	75
H1 [mm]	38
Accessories	N.A.
Notes	N.A.
Mounting tips	Not suitable for every application, please check

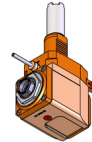

ATTENZIONE: VERIFICARE L'ORIENTAMENTO DELLA DENTATURA VDI

Always check live tool dimensions on the turret

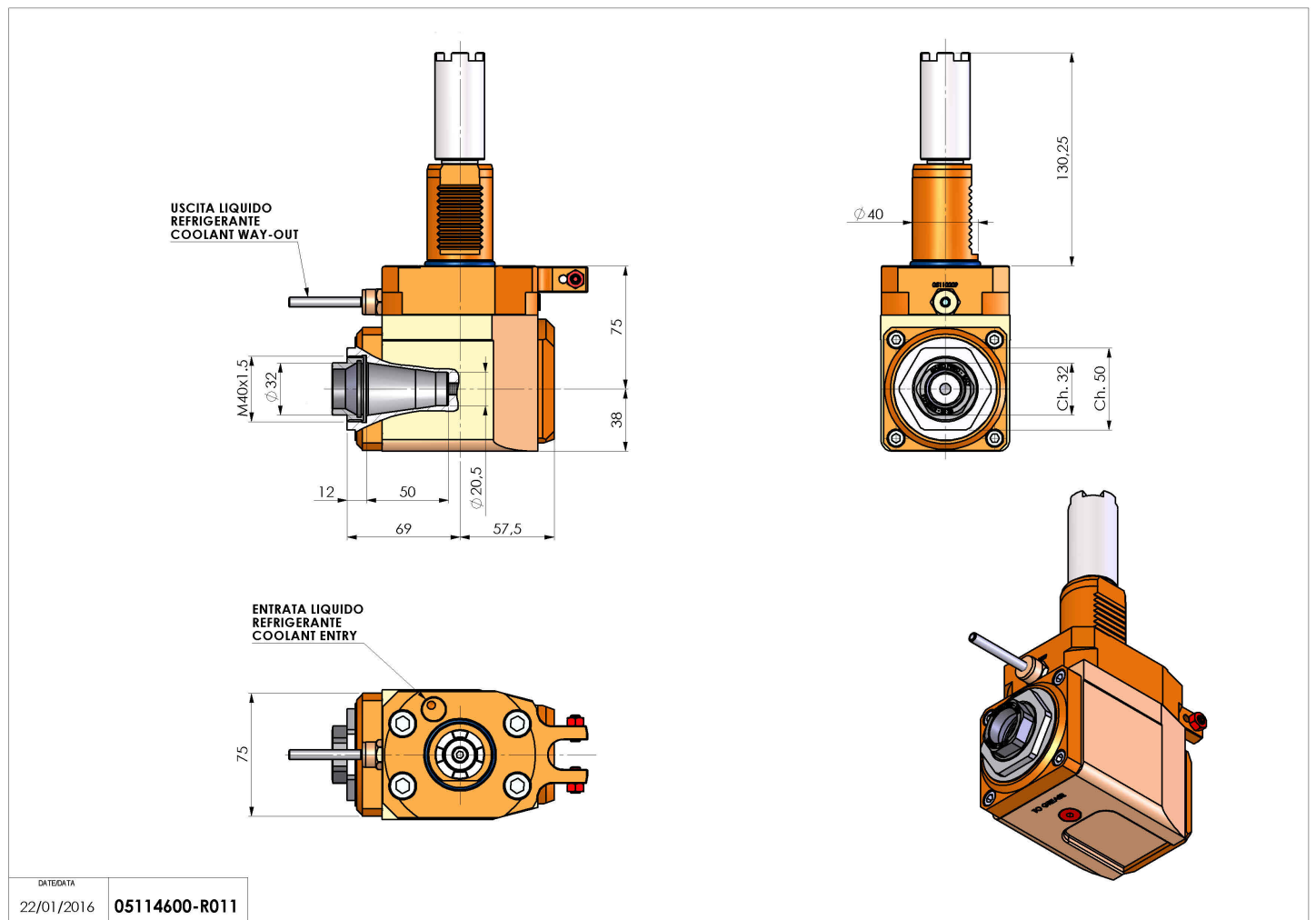

Subject to technical changes