



05090000 - LT-S D25 ER-25 H82 ROMI

Type	LT-S Tool holder straight
Mounting	CYLINDRICAL SHANK 25
Tool output	Collet nut ER 25
Coolant	External coolant
Direction of rotation	r1  r2 
Max speed [rpm]	6000
Max torque [Nm]	40
Ratio	1:1
H [mm]	82
Accessories	
Notes	N.A.
Mounting tips	Not suitable for every application, please check



Always check live tool dimensions on the turret

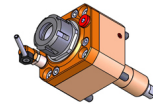
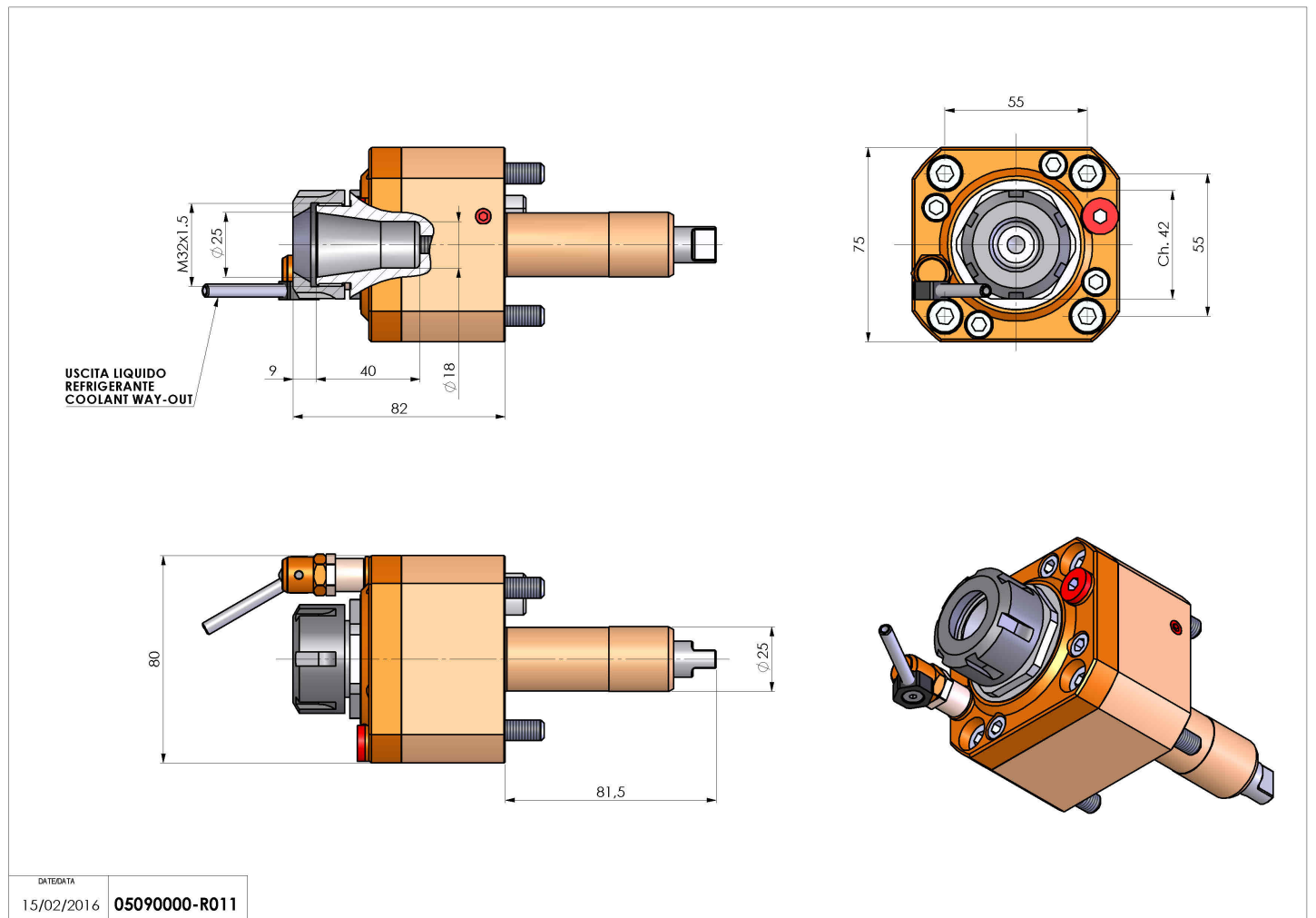

Subject to technical changes

DATE/DATE
15/02/2016 05090000-R011