

05052000 - LT-S VDI40ER32OFS-50H117MZ

Type	LT-S OFS Tool holder straight offset
Mounting	VDI 40
Tool output	Collet nut ER 32
Coolant	External coolant
Offset [mm]	50
Direction of rotation	r1 r2
Max speed [rpm]	6000
Max torque [Nm]	63
Ratio	1:1
H [mm]	117
Accessories	N.A.
Notes	N.A.

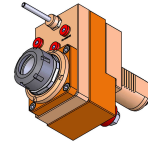

Mounting tips Not suitable for every application, please check

ATTENZIONE: VERIFICARE L'ORIENTAMENTO DELLA DENTATURA VDI

Always check live tool dimensions on the turret

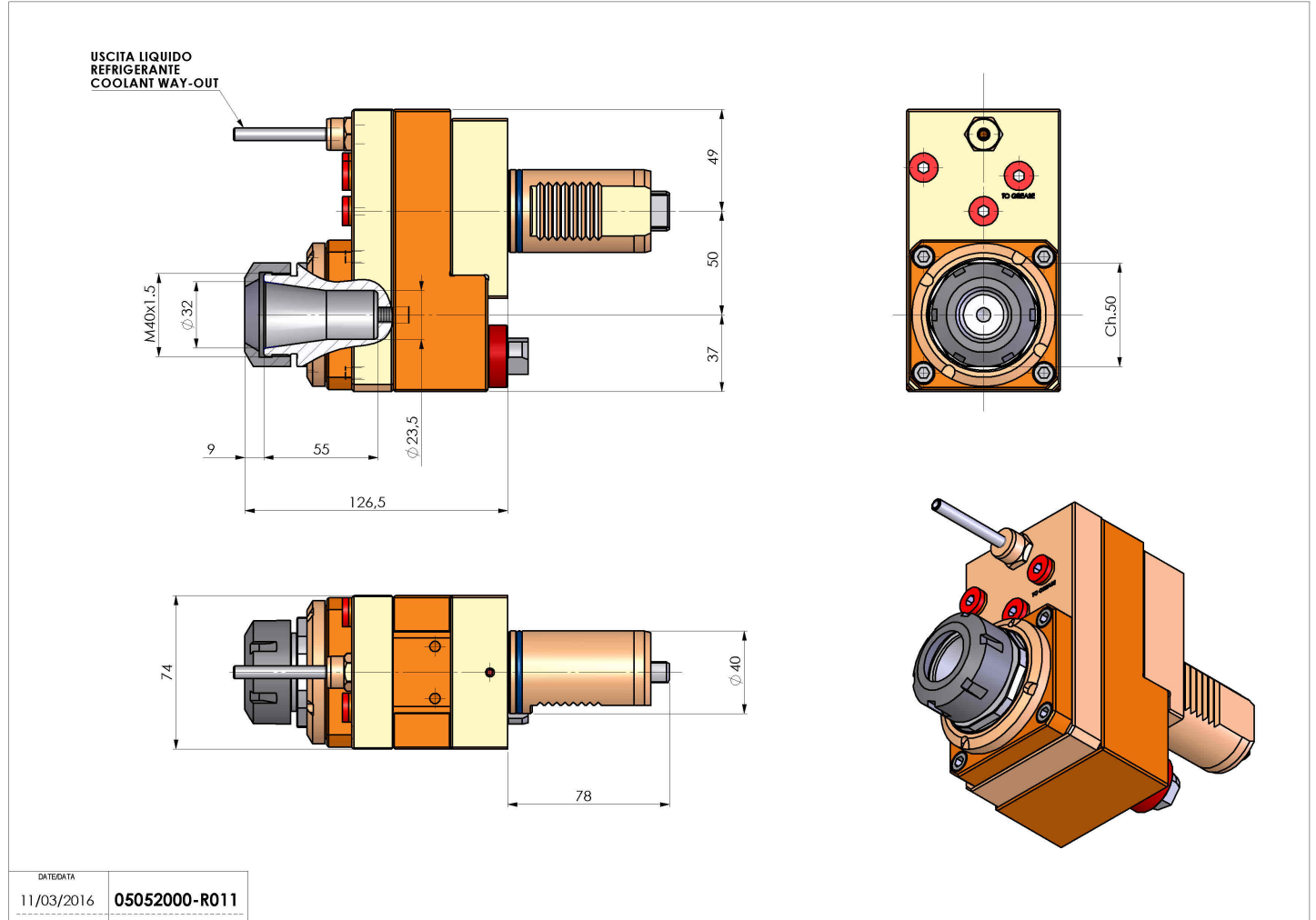

Subject to technical changes