

05015700 - LT-A D55 DIN138-22 H65 NK

Type	LT-A Tool holder angle 90°
Mounting	CYLINDRICAL SHANK 55
Tool output	Shell-Mill DIN138 22
Coolant	External coolant
Direction of rotation	r1 r2
Max speed [rpm]	6000
Max torque [Nm]	63
Ratio	1:1
H [mm]	65
H1 [mm]	32,5
Accessories	N.A.
Notes	N.A.
Mounting tips	Not suitable for every application, please check

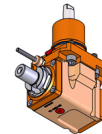

Always check live tool dimensions on the turret

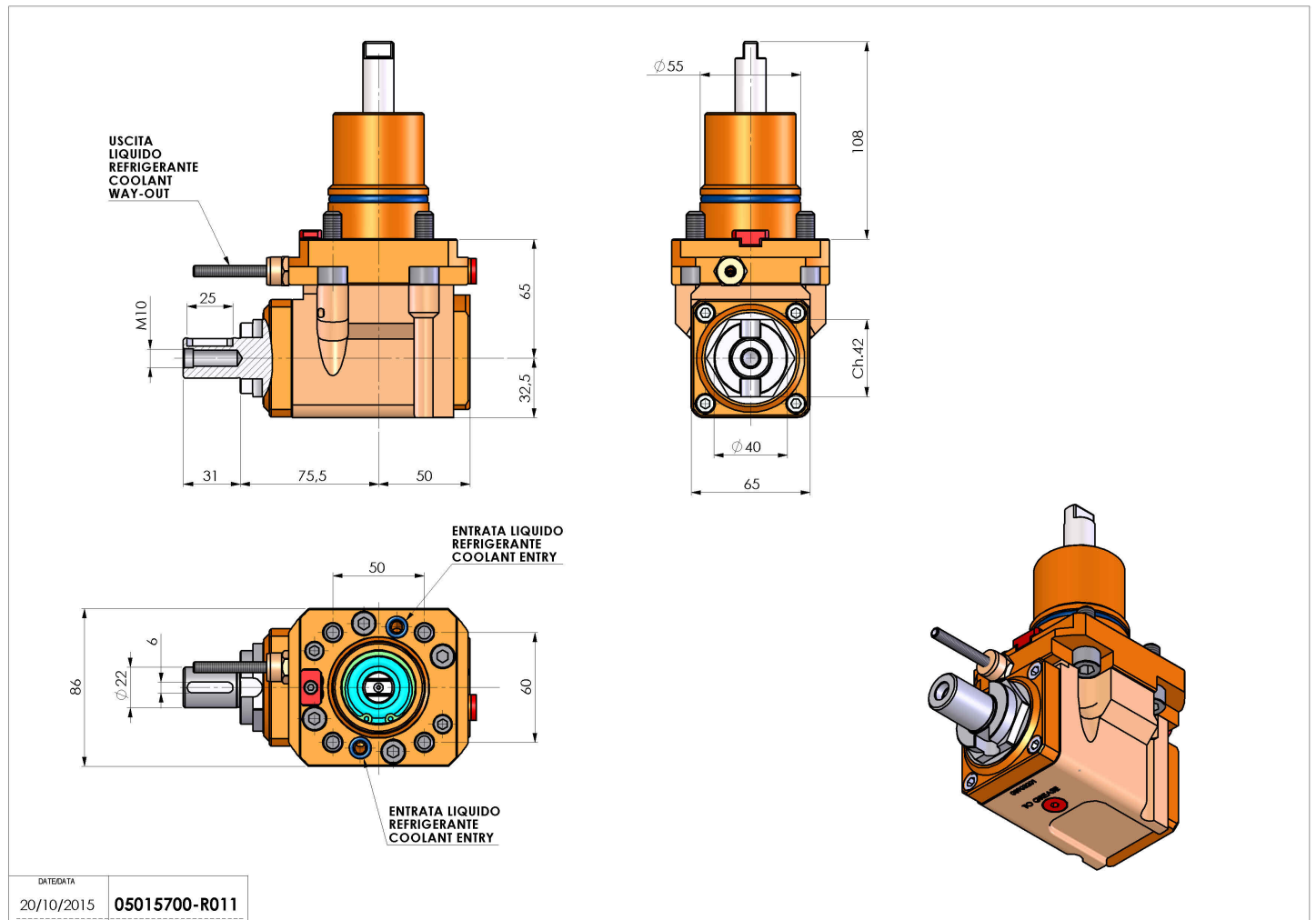

DATE/DATE	20/10/2015
PART NUMBER	05015700-R011

Subject to technical changes