

05013300 - LT-S D55 ER32 HRF HS H93

Type	LT-S Tool holder straight
Mounting	CYLINDRICAL SHANK 55
Tool output	Collet nut ER 32
Coolant	HP Internal/external coolant
Direction of rotation	r1 r2
Max speed [rpm]	10000
Max torque [Nm]	40
Ratio	1:1
H [mm]	93
Max pressure [bar]	70
Accessories	N.A.
Notes	N.A.
Mounting tips	Not suitable for every application, please check

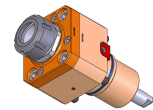

Always check live tool dimensions on the turret

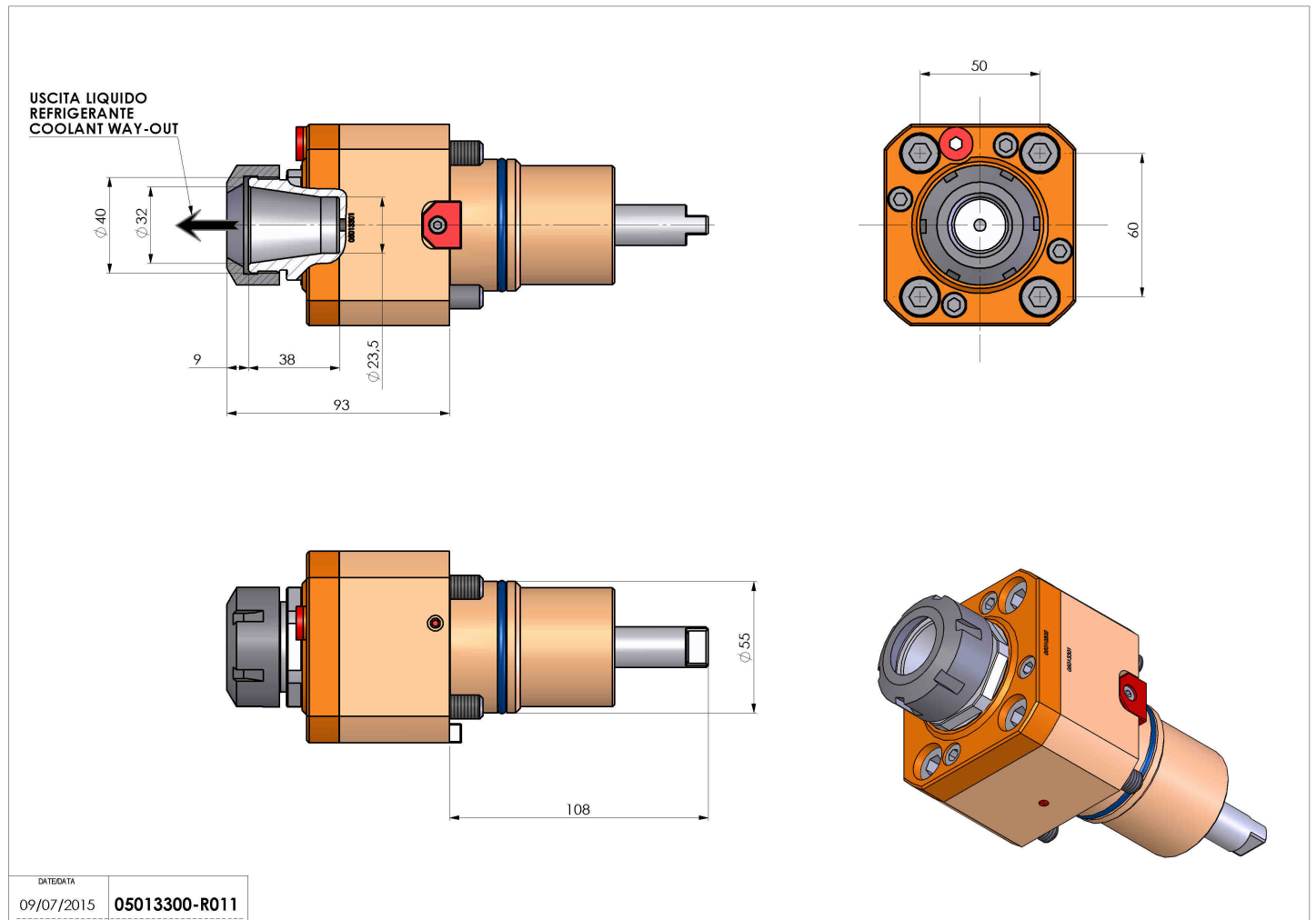

Subject to technical changes