

05010100 - LT-S D55 DIN138-22 H55 NK

Type	LT-S Tool holder straight
Mounting	CYLINDRICAL SHANK 55
Tool output	Shell-Mill DIN138 22
Coolant	External coolant
Direction of rotation	r1 r2
Max speed [rpm]	6000
Max torque [Nm]	63
Ratio	1:1
H [mm]	55
Accessories	
Notes	N.A.
Mounting tips	Not suitable for every application, please check

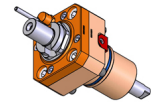

Always check live tool dimensions on the turret

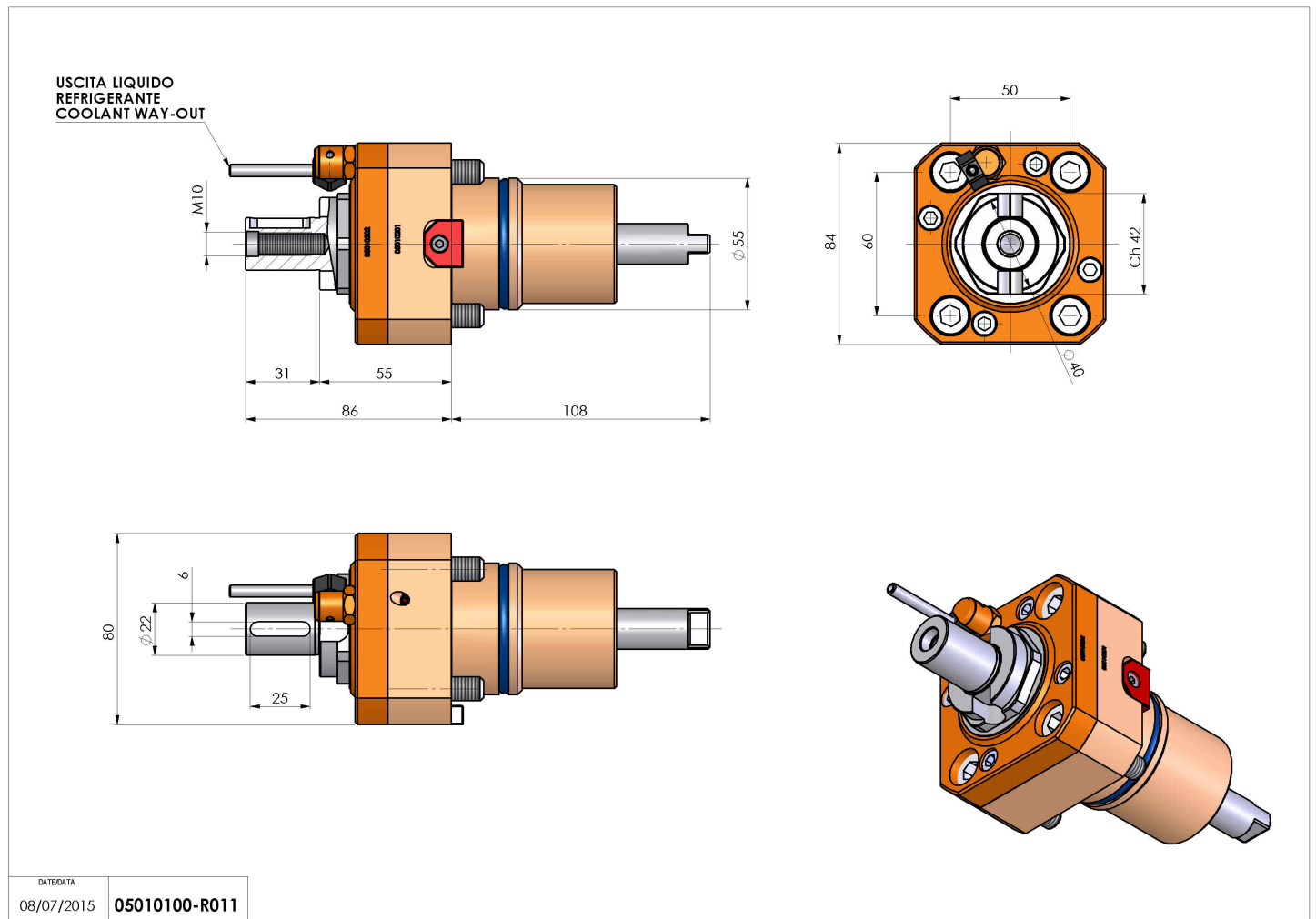

DATE/DATE	
08/07/2015	05010100-R011

Subject to technical changes