

01912500 - LT-A BMT75 D27 CONICO 4 H60

Type	LT SPECIALE Custom tool holder
Mounting	BMT 75
Tool output	D27 CONIC 4°
Coolant	External coolant
Direction of rotation	r1 ↻ r2 ↻
Max speed [rpm]	4000
Max torque [Nm]	80
Ratio	1:1
H [mm]	60
H1 [mm]	43
Accessories	N.A.
Notes	N.A.
Mounting tips	Not suitable for every application, please check

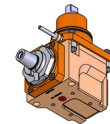

Always check live tool dimensions on the turret

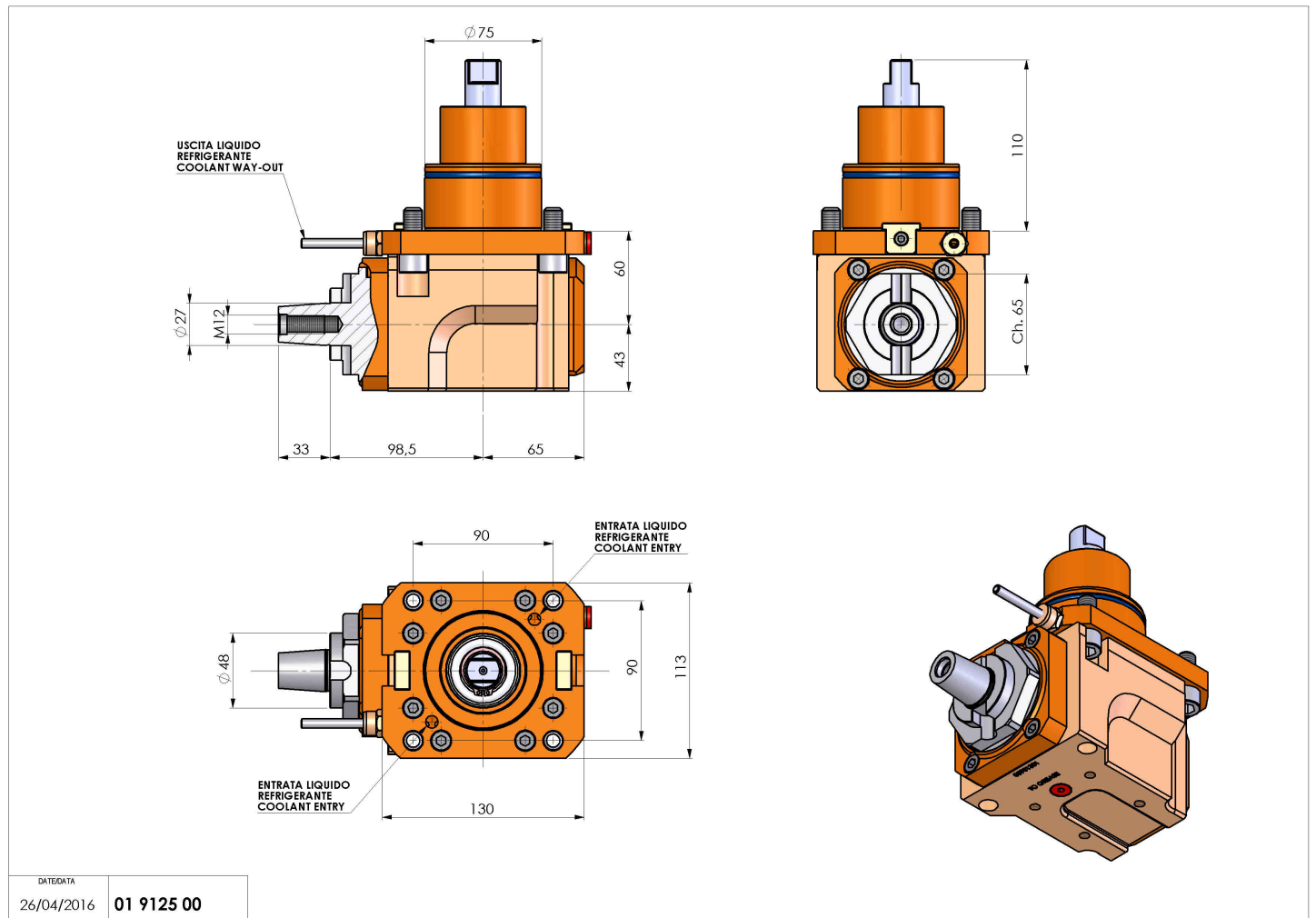

DATE/DATE
26/04/2016 01 9125 00

Subject to technical changes