

06307800 - TH-RAD BMT65 C40 RF H60

Type	TH-RAD Radial Tool holder
Mounting	BMT 65
Tool output	Polygonal shank C40 ISO 26623-1
Coolant	Internal coolant
H [mm]	60

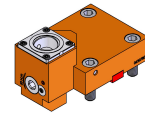

Accessories	N.A.
Notes	N.A.
Mounting tips	Not suitable for every application, please check

Always check live tool dimensions on the turret

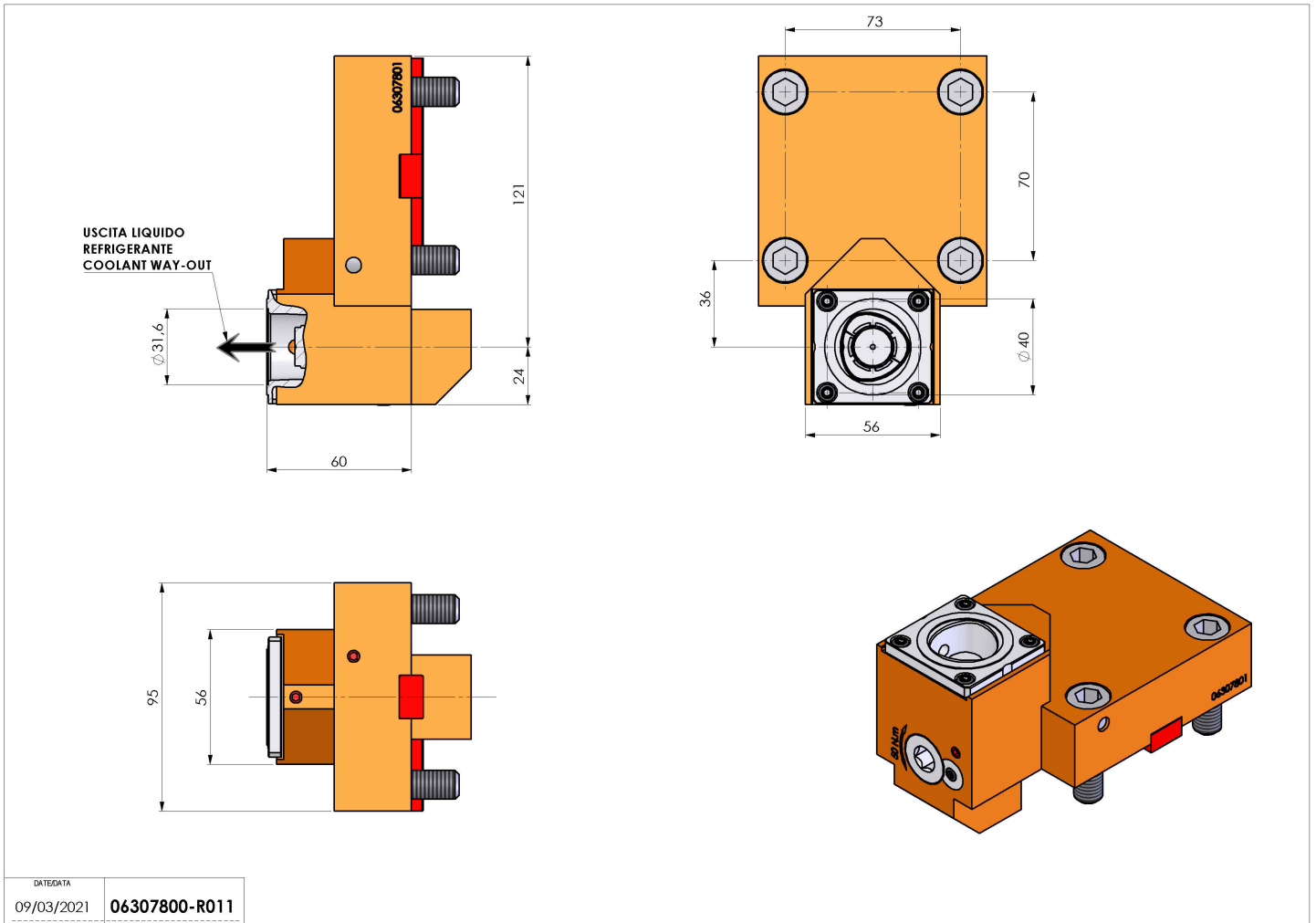

DATE/DATE	09/03/2021
06307800-R011	

Subject to technical changes