

06306500 - TH-BRB BMT75 D60 H50

Type	TH-BRB Boring bar holder
Mounting	BMT 75
Tool output	Boring Bar Holder 60
Coolant	External / Internal coolant
H [mm]	50

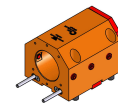

Accessories	N.A.
Notes	N.A.
Mounting tips	Not suitable for every application, please check

Always check live tool dimensions on the turret

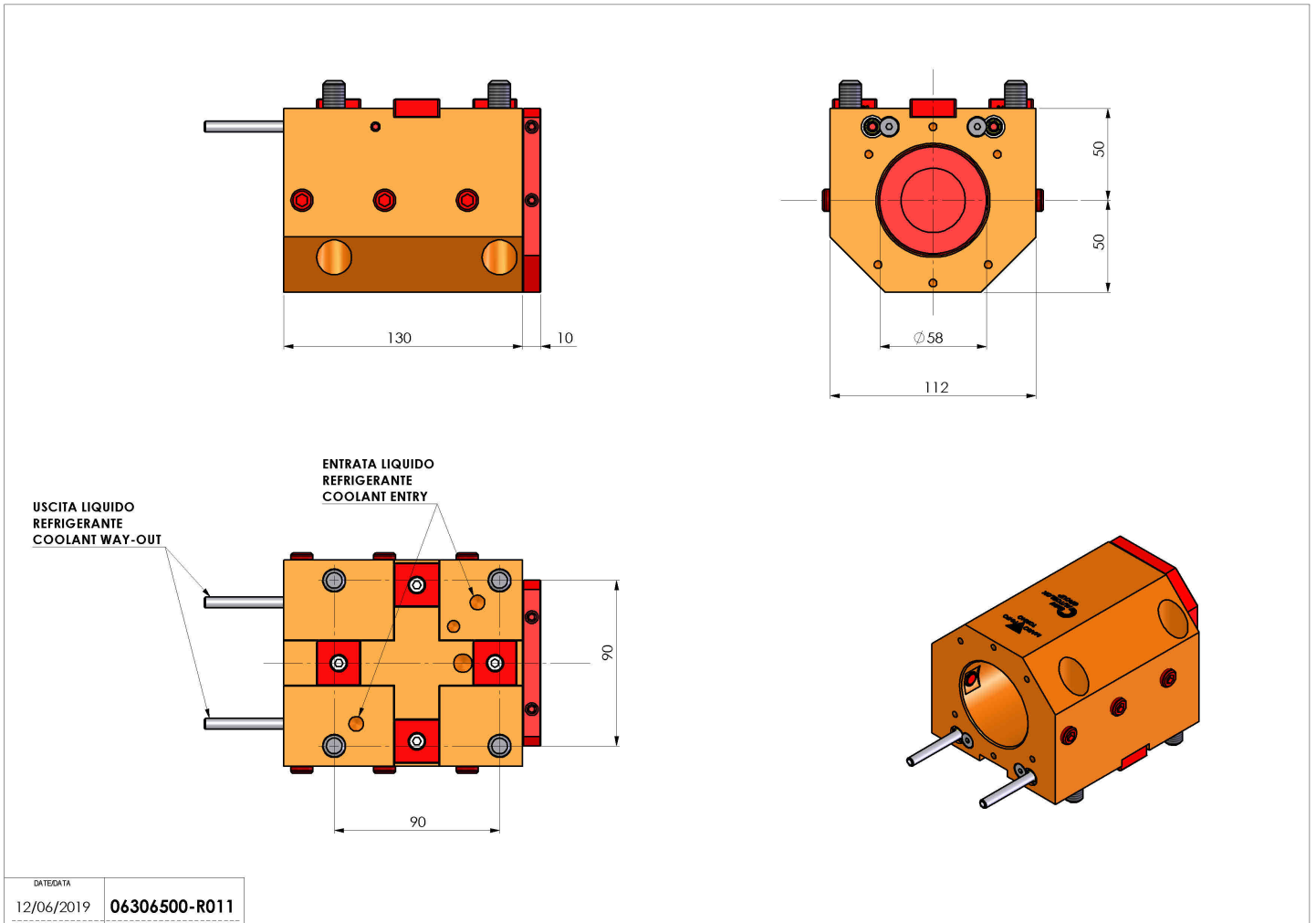

Subject to technical changes