

06304800 - TH-CUT BMT65 UT1-1/4" (32) H80

Type	TH-CUT Cutting holder
Mounting	BMT 65
Tool output	Cut Off Holder 1-1/4"(32)
Coolant	External coolant
H [mm]	80

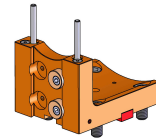

Accessories	N.A.
Notes	N.A.
Mounting tips	Not suitable for every application, please check

Always check live tool dimensions on the turret

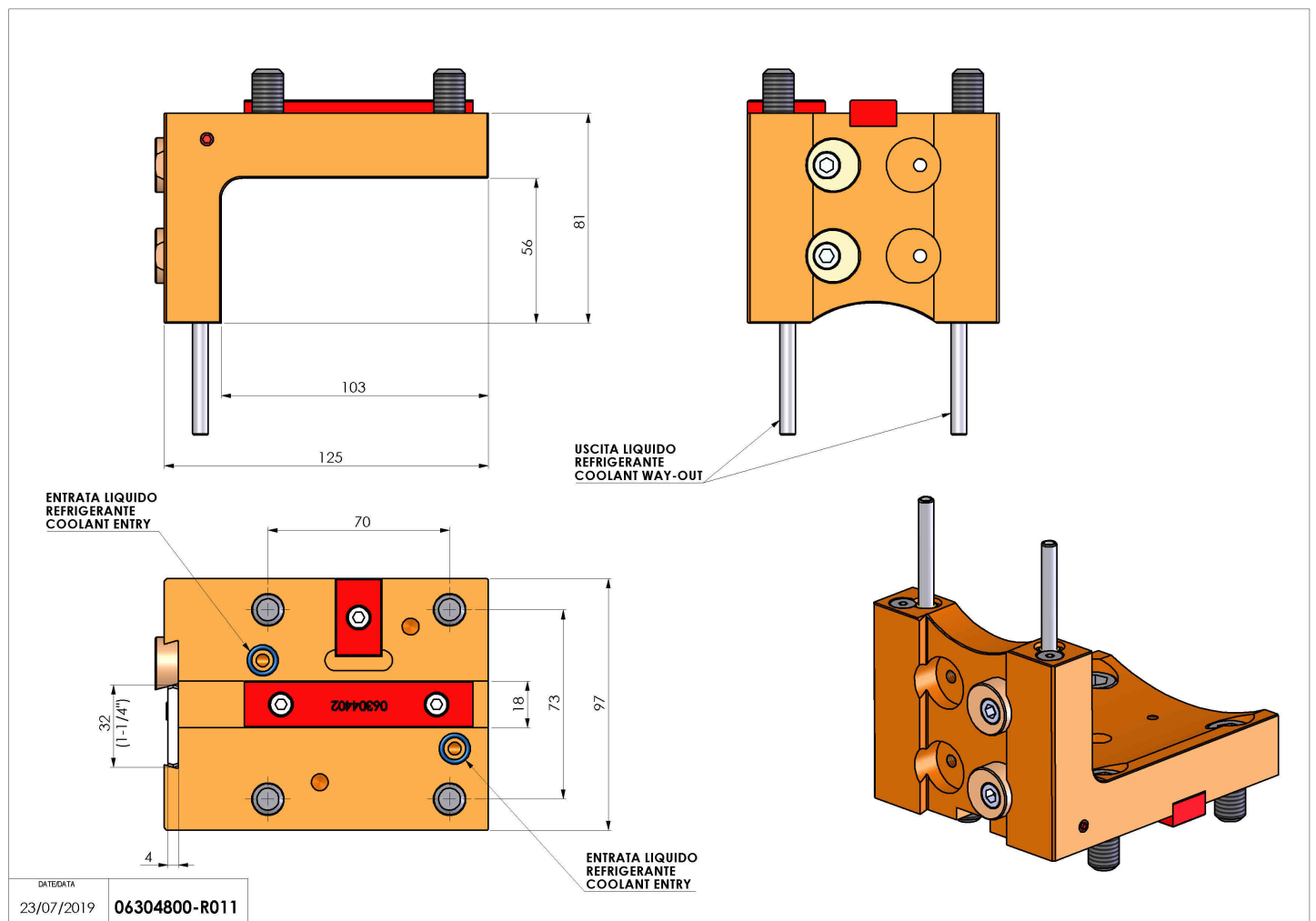

Subject to technical changes