

06303000 - TH-AX BMT55 1"X1" H90

Type	TH-AX Axial Tool holder
Mounting	BMT 55
Tool output	Axial Square Tool Holder 1" x 1"
Coolant	External coolant
H [mm]	90

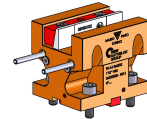

Accessories	N.A.
Notes	N.A.
Mounting tips	Not suitable for every application, please check

Always check live tool dimensions on the turret

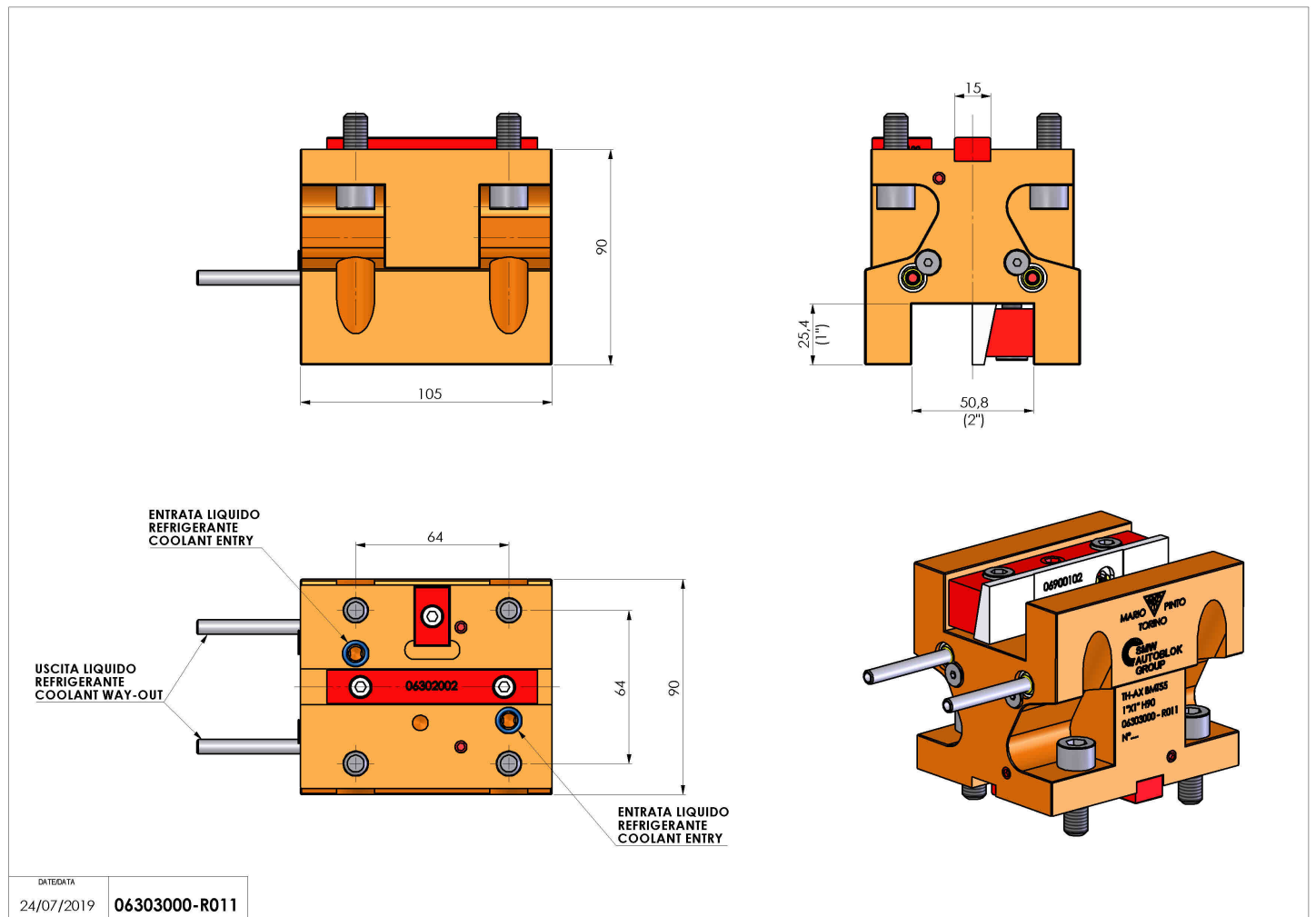

DATE/DATE	24/07/2019	06303000-R011
-----------	------------	---------------

Subject to technical changes