

06301000 - TH-RAD BMT45 C40 RF H52

Type	TH-RAD Radial Tool holder
Mounting	BMT 45
Tool output	Polygonal shank C40 ISO 26623-1
Coolant	Internal coolant
H [mm]	60
Accessories	N.A.
Notes	N.A.
Mounting tips	Not suitable for every application, please check

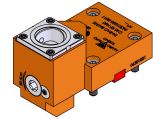

Always check live tool dimensions on the turret

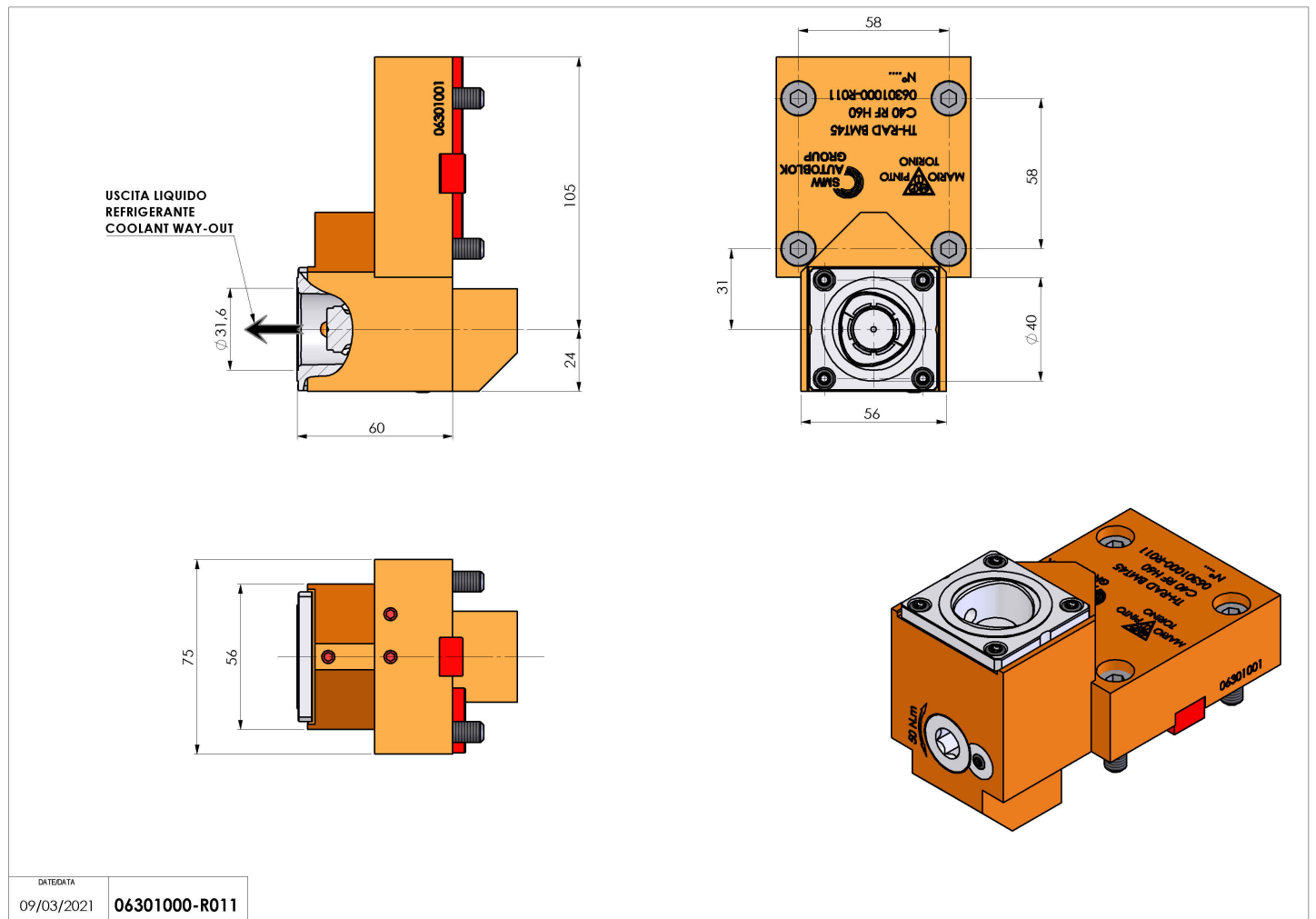

DATE/DATE	09/03/2021
	06301000-R011

Subject to technical changes