

06254200 - TH-AX VDI50 C40 RF H175

Type	TH-AX Axial Tool holder
Mounting	VDI 50
Tool output	Polygonal shank C40 ISO 26623-1
Coolant	Internal coolant
H [mm]	175



Accessories	N.A.
Notes	N.A.
Mounting tips	Not suitable for every application, please check

ATTENZIONE: VERIFICARE L'ORIENTAMENTO DELLA DENTATURA VDI

Always check live tool dimensions on the turret

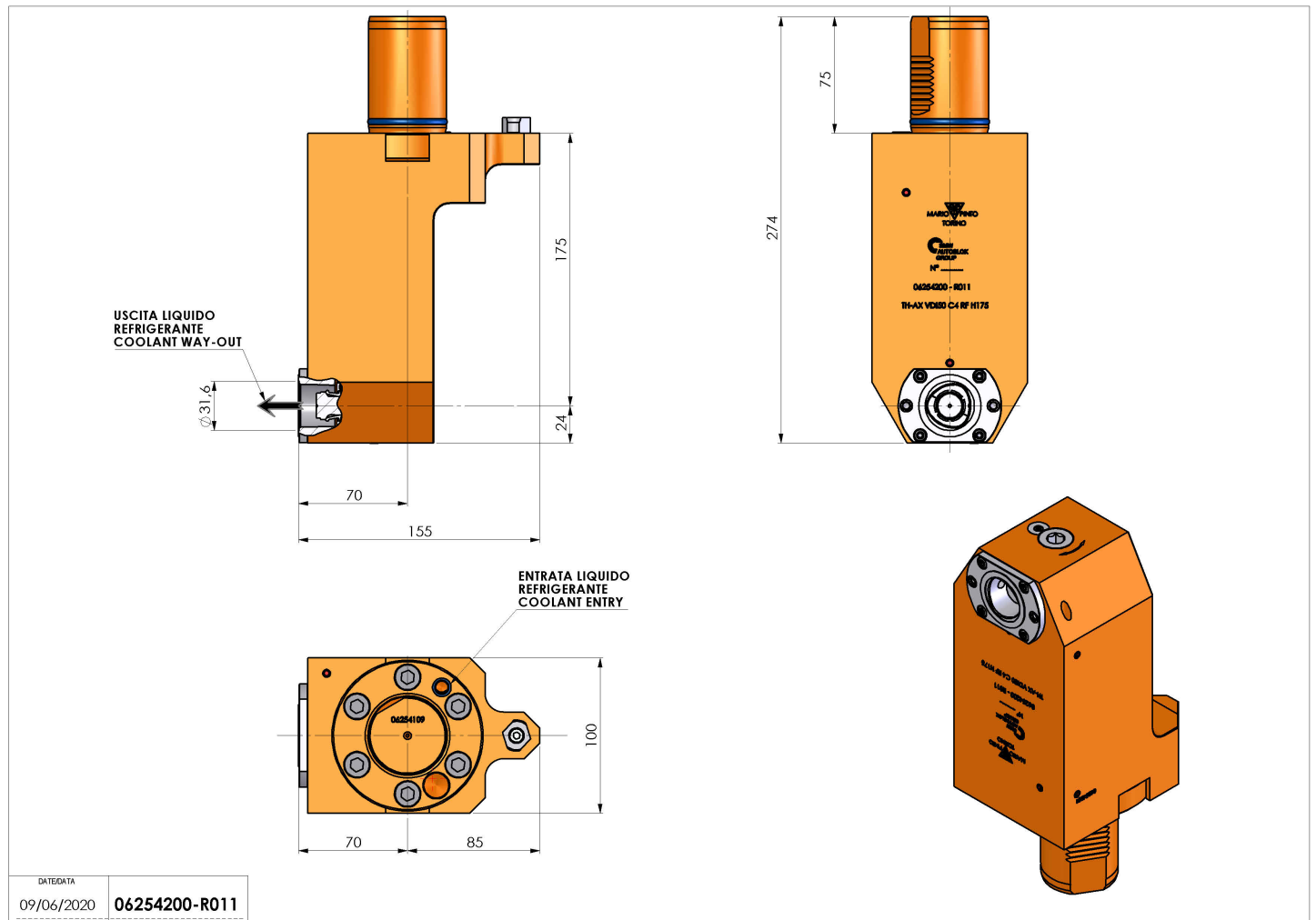

Subject to technical changes