

06233100 - TH-RAD BMT75EM C50 R H87

Type	TH-RAD Radial Tool holder
Mounting	BMT 75 EM
Tool output	Polygonal shank C50 ISO 26623-1
Coolant	Internal coolant
H [mm]	87

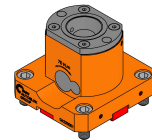

Accessories	N.A.
Notes	N.A.
Mounting tips	Not suitable for every application, please check

Always check live tool dimensions on the turret

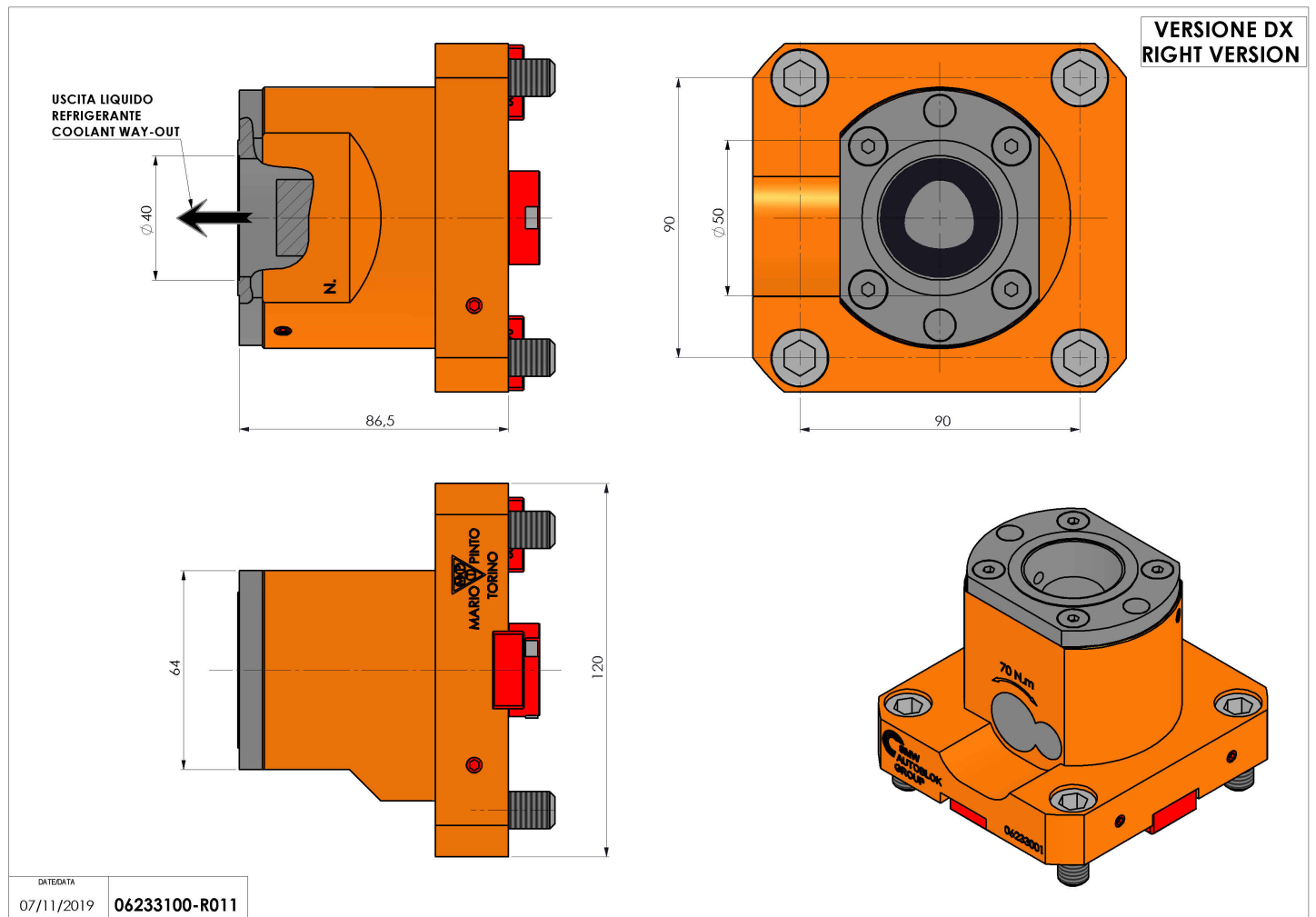

Subject to technical changes