

## 06230900 - TH-BRB BMT65EM D40 H90

Type	TH-BRB Boring bar holder
Mounting	BMT 65 EM
Tool output	Boring Bar Holder 40
Coolant	External / Internal coolant
H [mm]	90
Accessories	N.A.
Notes	N.A.
Mounting tips	Not suitable for every application, please check

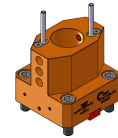

Always check live tool dimensions on the turret

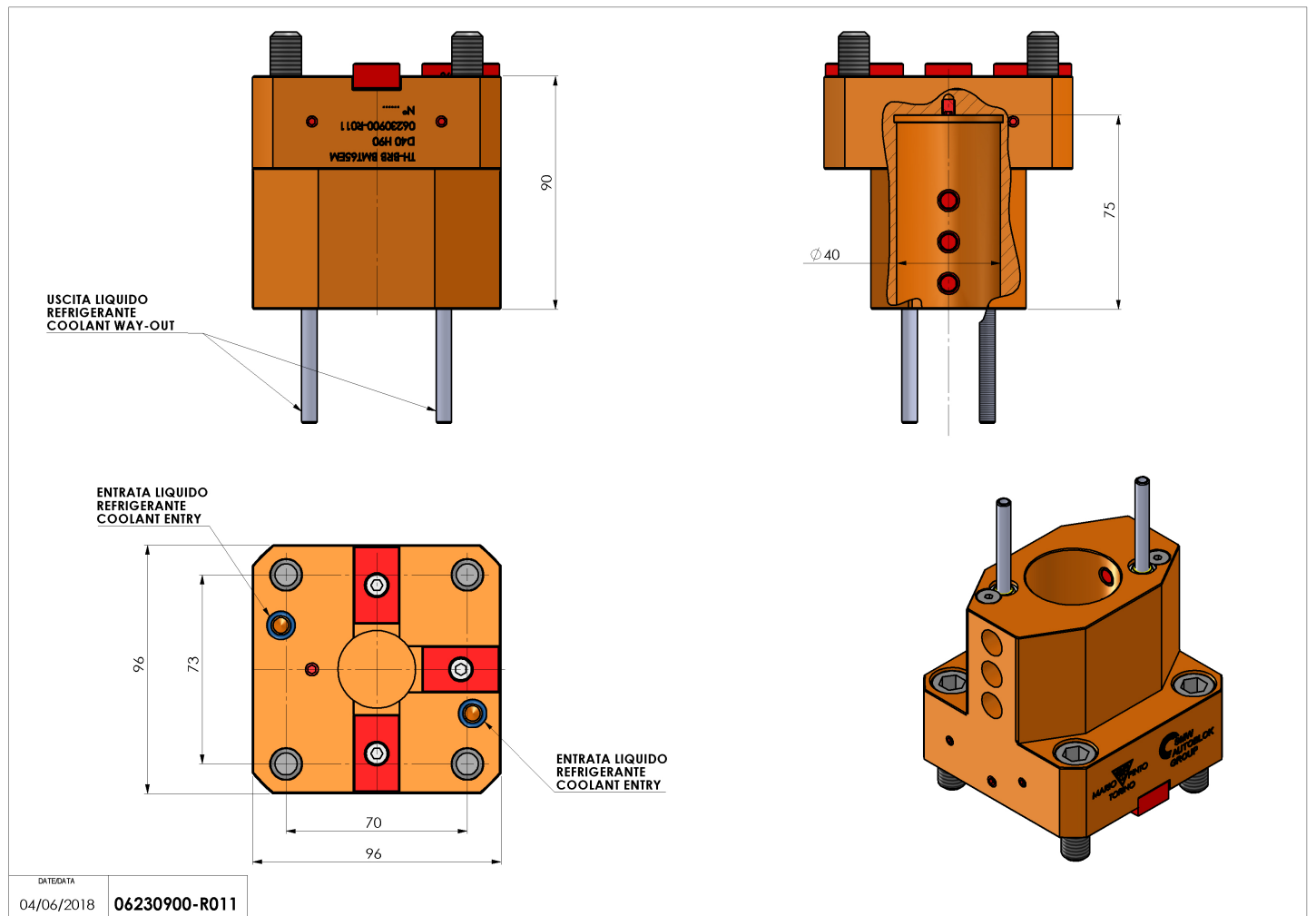

Subject to technical changes