

06230800 - TH-BRB BMT55EM D20 H75

Type	TH-BRB Boring bar holder
Mounting	BMT 55 EM
Tool output	Boring Bar Holder 20
Coolant	External / Internal coolant
H [mm]	75
Accessories	N.A.
Notes	N.A.
Mounting tips	Not suitable for every application, please check

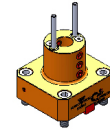

Always check live tool dimensions on the turret

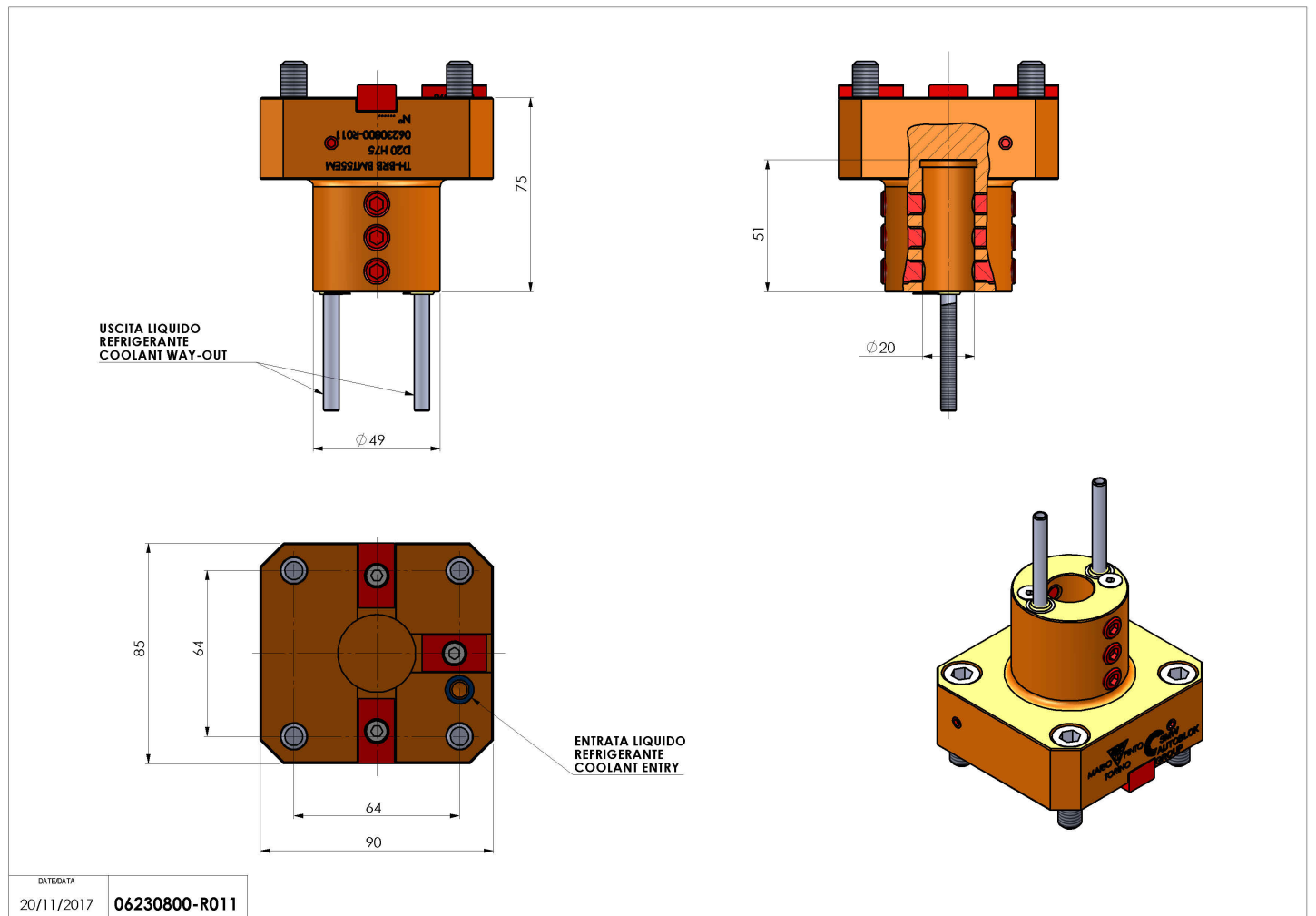

Subject to technical changes