

06156400 - TH-AX P18 C50 RF H130

Type	TH-AX Axial Tool holder
Mounting	PIN Ø18 (D55)
Tool output	Polygonal shank C50 ISO 26623-1
Coolant	Internal coolant
H [mm]	130
Accessories	N.A.
Notes	N.A.
Mounting tips	Not suitable for every application, please check

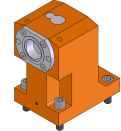

Always check live tool dimensions on the turret

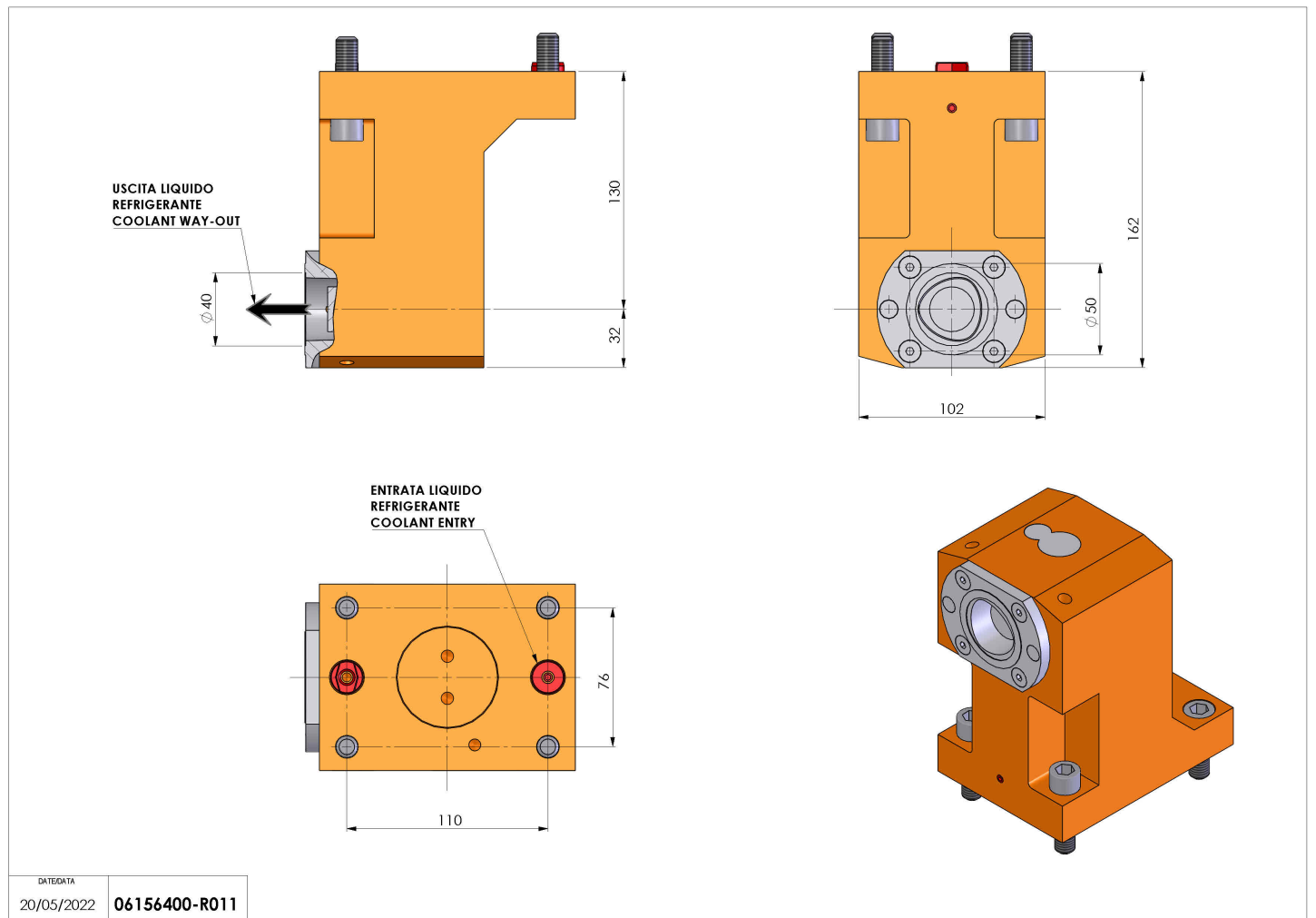

Subject to technical changes