

06153300 - TH-BRB P12 D40 H95

Type	TH-BRB Boring bar holder
Mounting	PIN Ø12 (D40)
Tool output	Boring Bar Holder 40
Coolant	External / Internal coolant
H [mm]	95
Accessories	N.A.
Notes	N.A.
Mounting tips	Not suitable for every application, please check

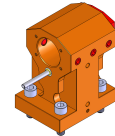

Always check live tool dimensions on the turret

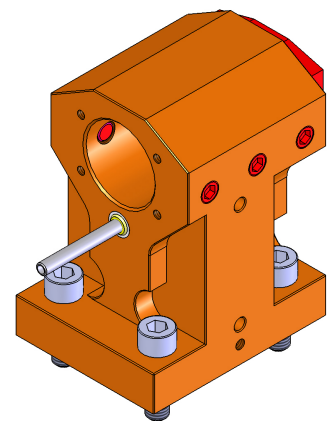
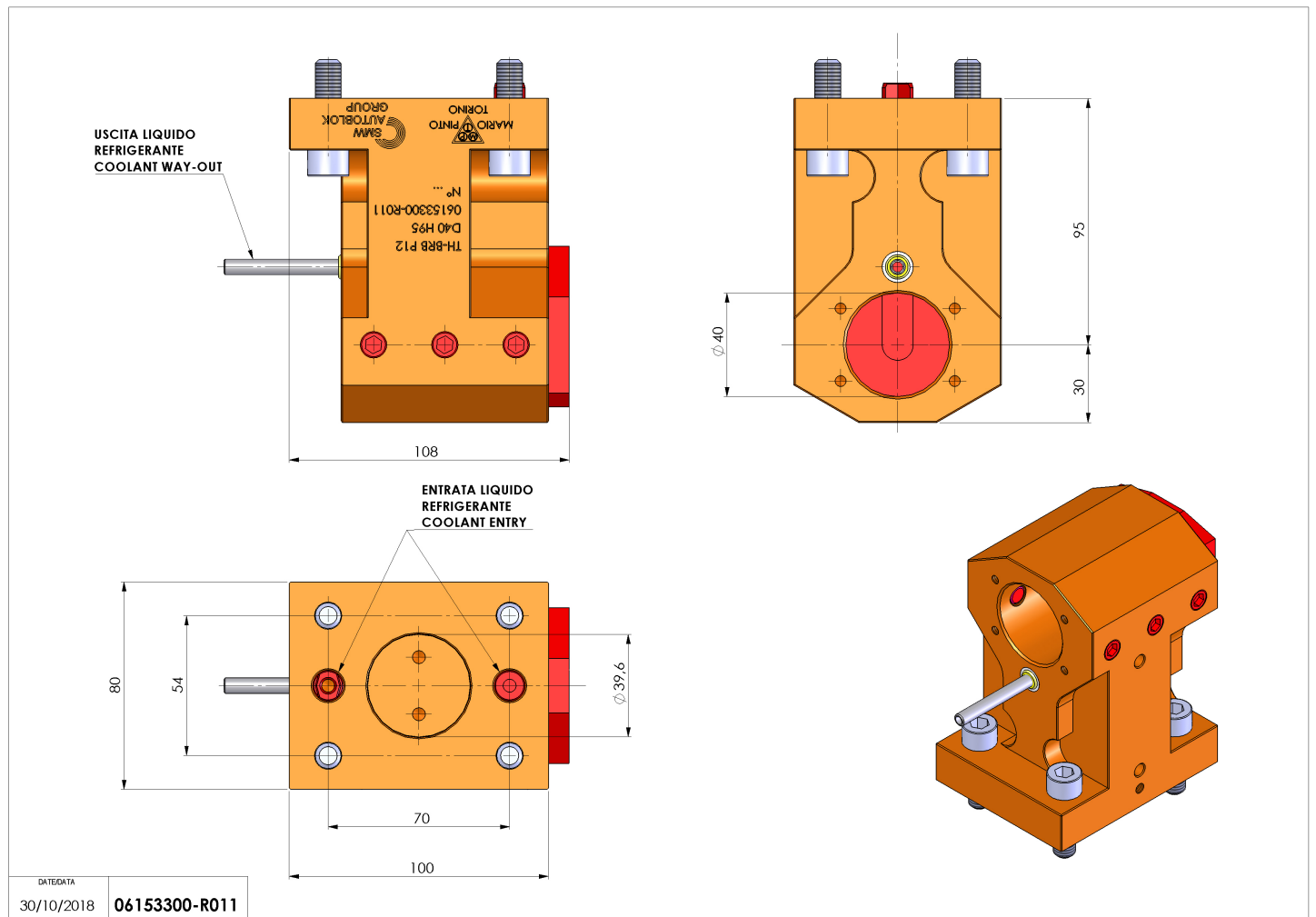

Subject to technical changes