

06063200 - TH-AX D60 Q25 H70

Type	TH-AX Axial Tool holder
Mounting	CYLINDRICAL SHANK 60
Tool output	Axial Square Tool Holder 25x25
Coolant	External coolant
H [mm]	70
Accessories	N.A.
Notes	N.A.
Mounting tips	Not suitable for every application, please check

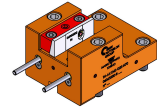

Always check live tool dimensions on the turret

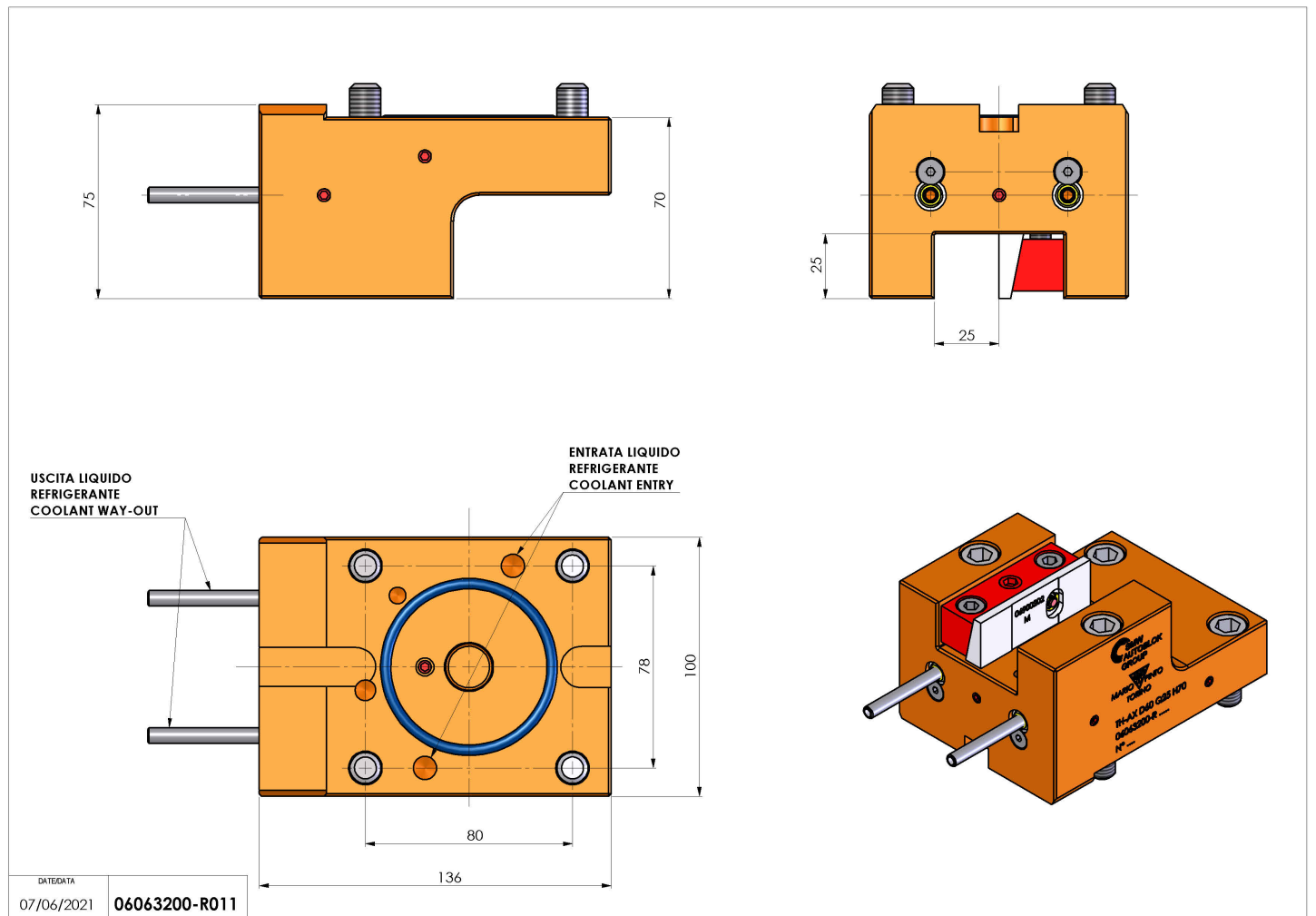

Subject to technical changes