

## 06059700 - TH-AX VDI40 C50 RF H140

Type	TH-AX Axial Tool holder
Mounting	VDI 40
Tool output	Polygonal shank C50 ISO 26623-1
Coolant	Internal coolant
H [mm]	140

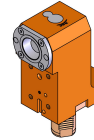

Accessories	N.A.
Notes	N.A.
Mounting tips	Not suitable for every application, please check

**ATTENZIONE: VERIFICARE L'ORIENTAMENTO DELLA DENTATURA VDI**

Always check live tool dimensions on the turret

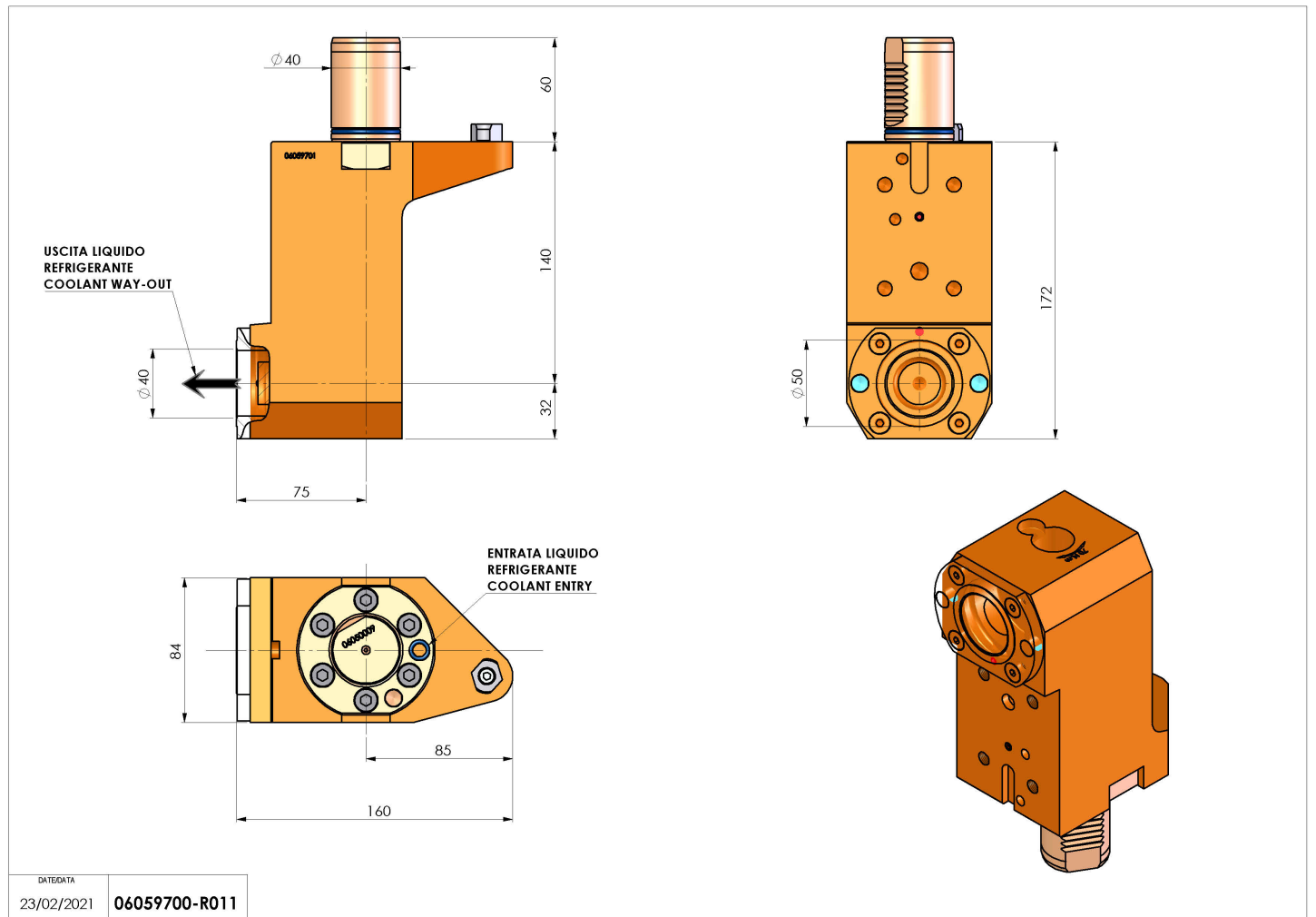

Subject to technical changes