

06057300 - TH-AX VDI40 H160 DX-SX MZ

Type	TH-AX Axial Tool holder
Mounting	VDI 40
Tool output	Axial Square Tool Holder 25x25
Coolant	External coolant
H [mm]	160

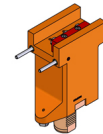

Accessories	N.A.
Notes	N.A.
Mounting tips	Not suitable for every application, please check

ATTENZIONE: VERIFICARE L'ORIENTAMENTO DELLA DENTATURA VDI

Always check live tool dimensions on the turret

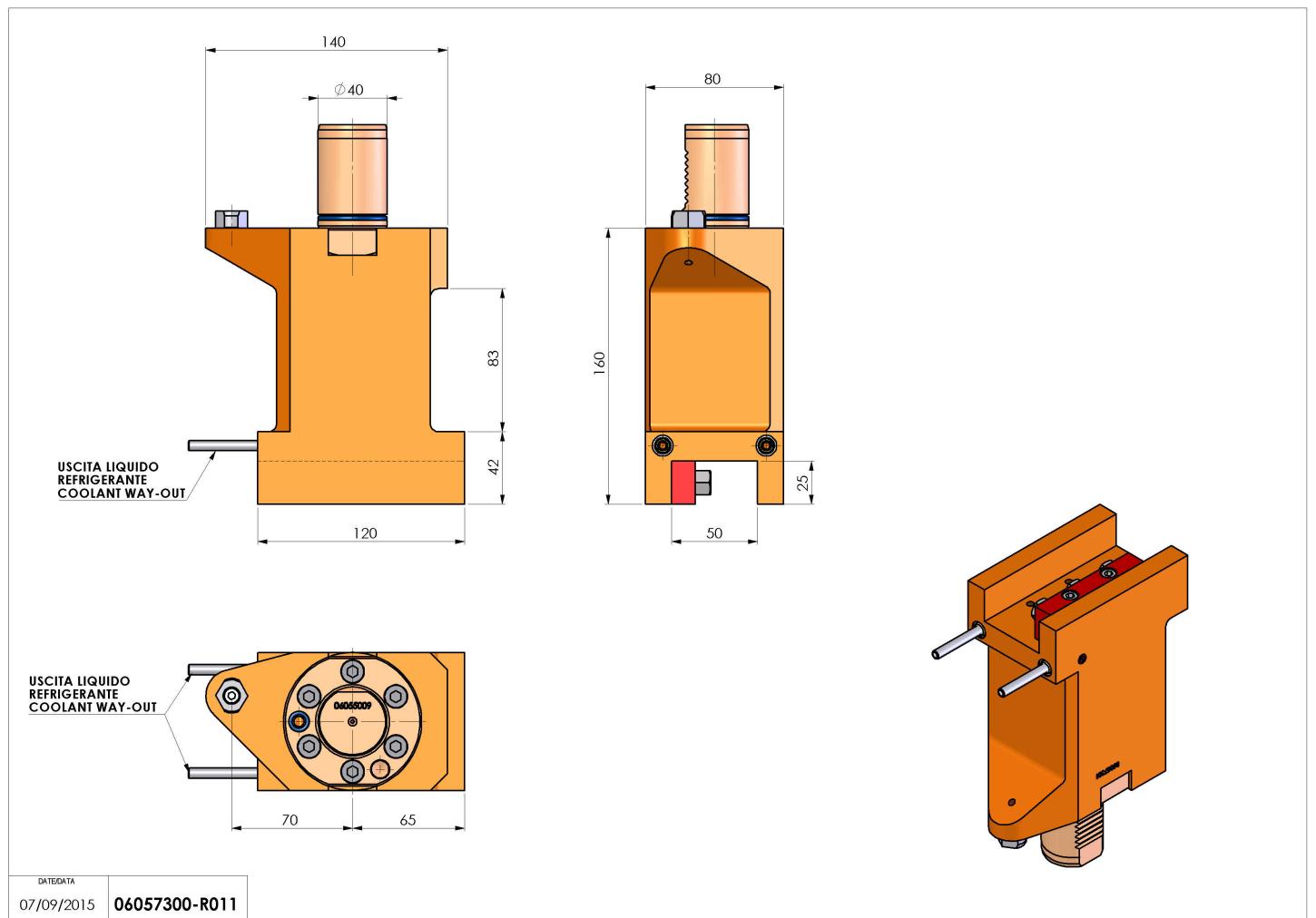

Subject to technical changes