

06053300 - TH-RAD VDI40 C40 RF H85

Type	TH-RAD Radial Tool holder
Mounting	VDI 40
Tool output	Polygonal shank C40 ISO 26623-1
Coolant	Internal coolant
H [mm]	85

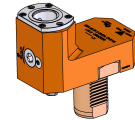

Accessories	N.A.
Notes	N.A.
Mounting tips	Not suitable for every application, please check

ATTENZIONE: VERIFICARE L'ORIENTAMENTO DELLA DENTATURA VDI

Always check live tool dimensions on the turret

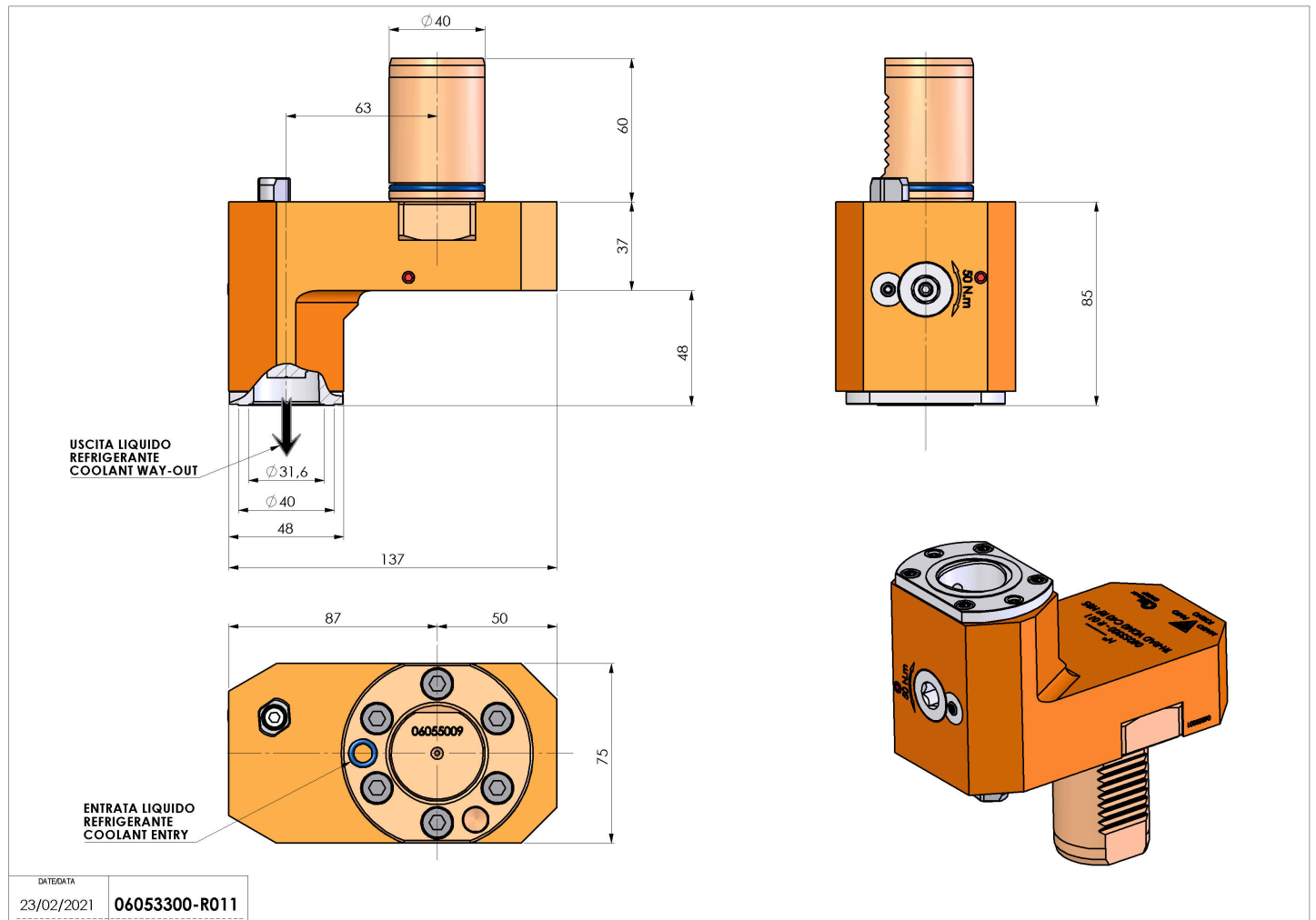

Subject to technical changes