

06011000 - TH-BRB D44 D20 H65 NK

Type	TH-BRB Boring bar holder
Mounting	CYLINDRICAL SHANK 44
Tool output	Boring Bar Holder 20
Coolant	External / Internal coolant
H [mm]	65

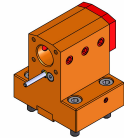

Accessories	N.A.
Notes	N.A.
Mounting tips	Not suitable for every application, please check

Always check live tool dimensions on the turret

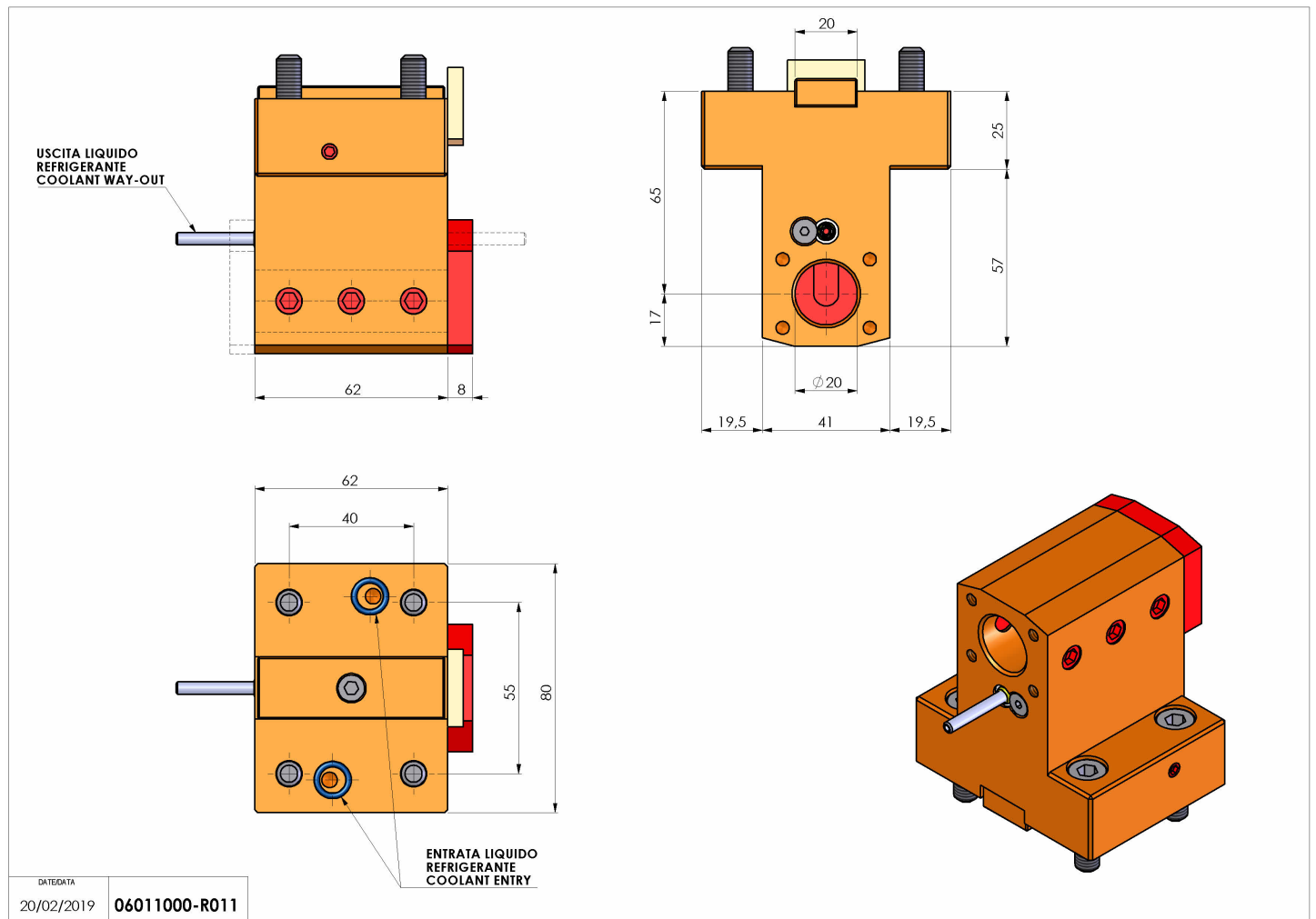

Subject to technical changes