



05385100 - LT-S D65 ER32F RF H69

Type	LT-S Tool holder straight
Mounting	CYLINDRICAL SHANK 65
Tool output	Collet nut ER 32 F - internal nut
Coolant	Internal coolant
Direction of rotation	r1  r2 
Max speed [rpm]	6000
Max torque [Nm]	70
Ratio	1:1
H [mm]	69
Accessories	N.A.
Notes	N.A.
Mounting tips	Not suitable for every application, please check



Always check live tool dimensions on the turret

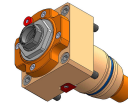
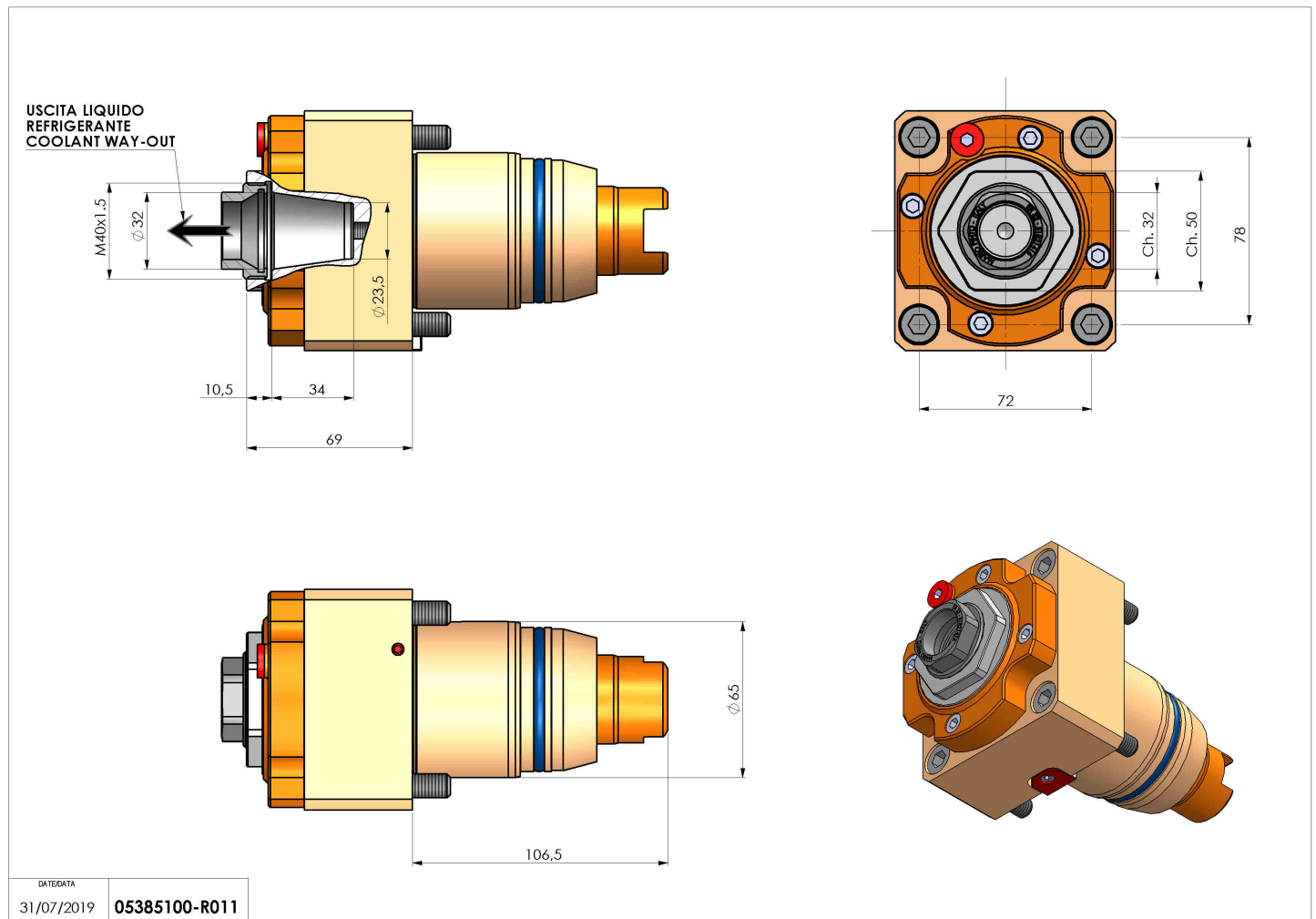

Subject to technical changes