

05370800 - LT-S D40 ER20F HRF H74

Type	LT-S Tool holder straight
Mounting	CYLINDRICAL SHANK 40
Tool output	Collet nut ER 20 F - internal nut
Coolant	HP Internal coolant
Direction of rotation	r1 r2
Max speed [rpm]	6000
Max torque [Nm]	25
Ratio	1:1
H [mm]	74
Max pressure [bar]	70
Accessories	N.A.
Notes	N.A.
Mounting tips	Not suitable for every application, please check

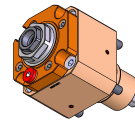

Always check live tool dimensions on the turret

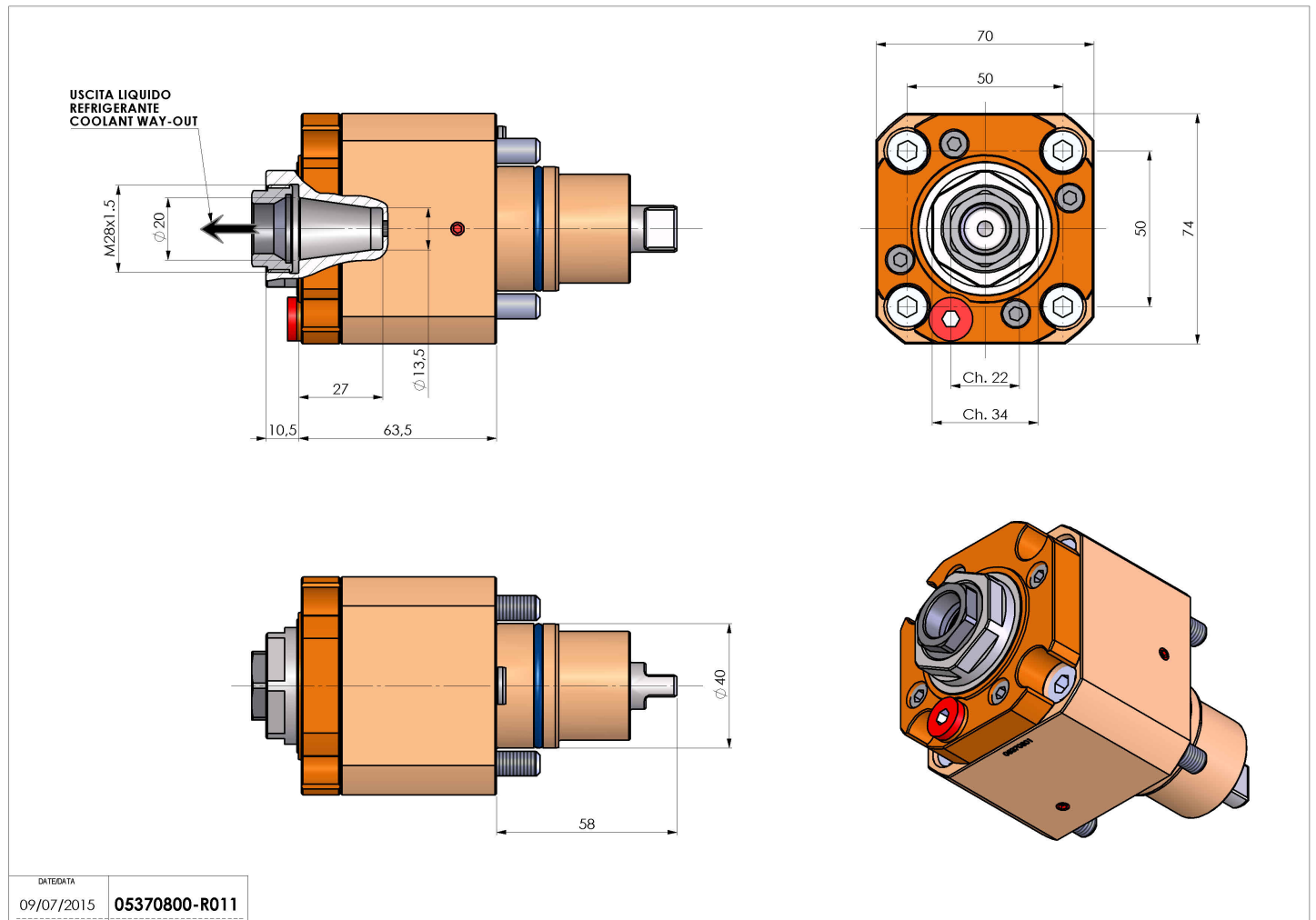

Subject to technical changes