

05356000 - LT-A VDI40 C4 RFH-PR H115 MZ

Type	LT-A Tool holder angle 90°
Mounting	VDI 40
Tool output	Polygonal shank C40 ISO 26623-1
Coolant	Internal coolant
Direction of rotation	r1 ↻ r2 ↻
Max speed [rpm]	6000
Max torque [Nm]	63
Ratio	1:1
H [mm]	115
H1 [mm]	41
Max pressure [bar]	80
Accessories	N.A.
Notes	N.A.
Mounting tips	Not suitable for every application, please check

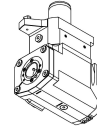

REPLACED BY 05356400

ATTENZIONE: VERIFICARE L'ORIENTAMENTO DELLA DENTATURA VDI

Always check live tool dimensions on the turret

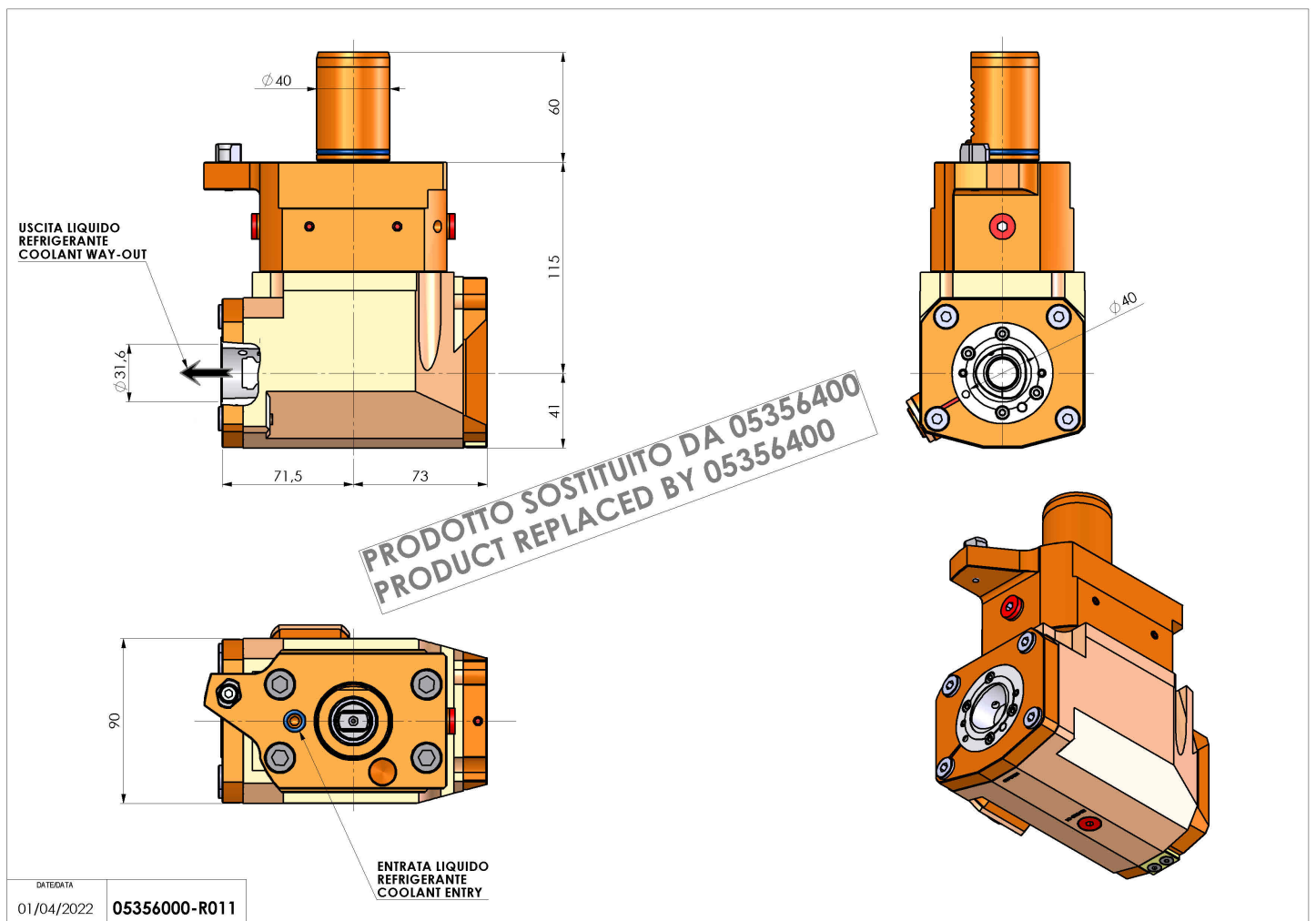

Subject to technical changes