

05329100 - LT-A BMT55 ER25F LR HRF H85

Type	LT-A Tool holder angle 90°
Mounting	BMT 55
Tool output	Collet nut ER 25 F - internal nut
Coolant	HP Internal coolant
Direction of rotation	r1 ↻ r2 ↻
Max speed [rpm]	6000
Max torque [Nm]	40
Ratio	1:1
H [mm]	85
H1 [mm]	32.5
Max pressure [bar]	80
Accessories	N.A.
Notes	N.A.
Mounting tips	Not suitable for every application, please check

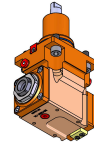

Always check live tool dimensions on the turret

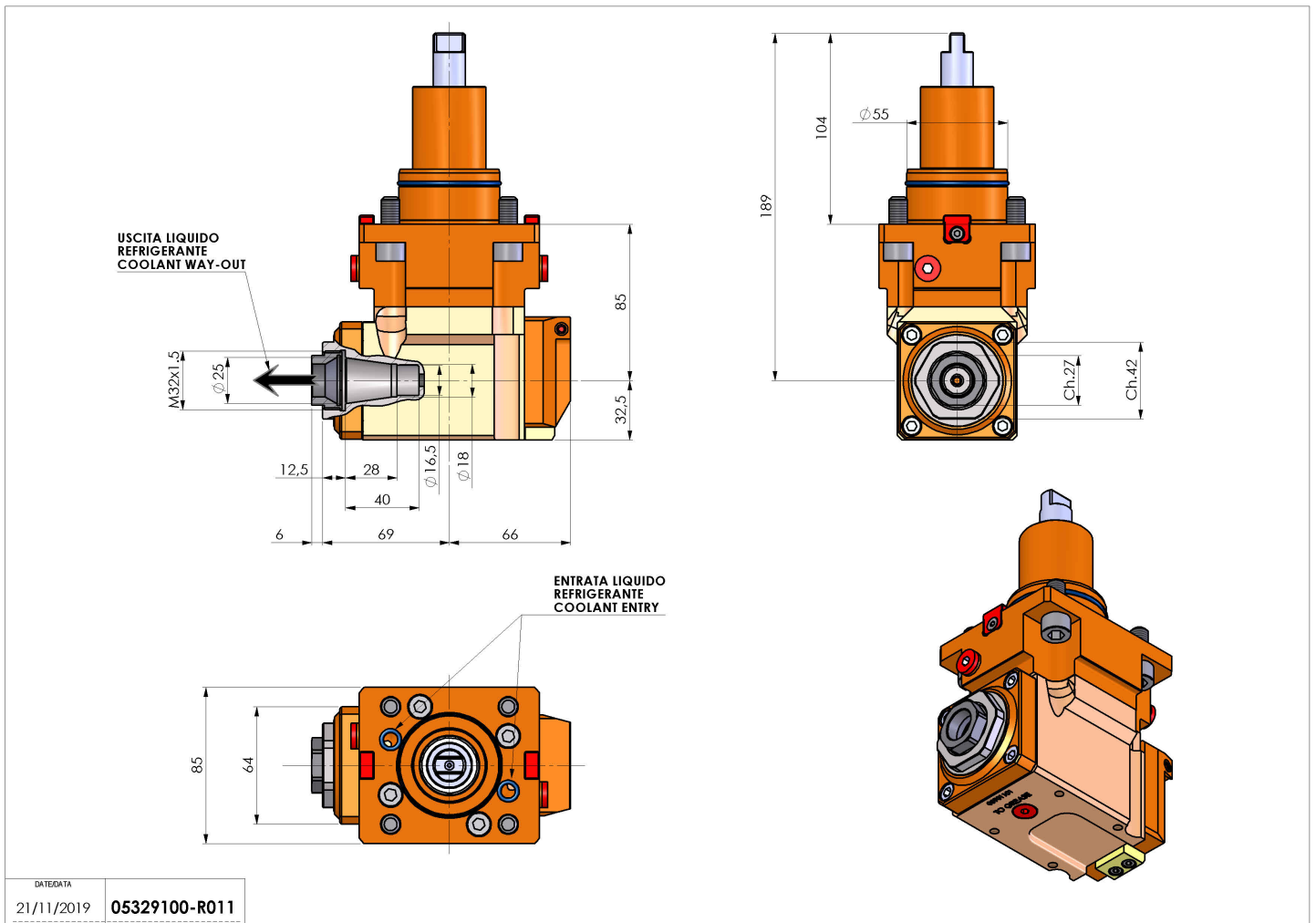

DATE/DATE	05329100-R011
21/11/2019	

Subject to technical changes