



05313900 - LT-S BMT65 BD ER32 H86

Type	LT-S Tool holder straight
Mounting	BMT 65 BIG DRIVE
Tool output	Collet nut ER 32
Coolant	External coolant
Direction of rotation	r1  r2 
Max speed [rpm]	6000
Max torque [Nm]	70
Ratio	1:1
H [mm]	86
Accessories	N.A.
Notes	N.A.
Mounting tips	Not suitable for every application, please check



Always check live tool dimensions on the turret

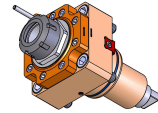
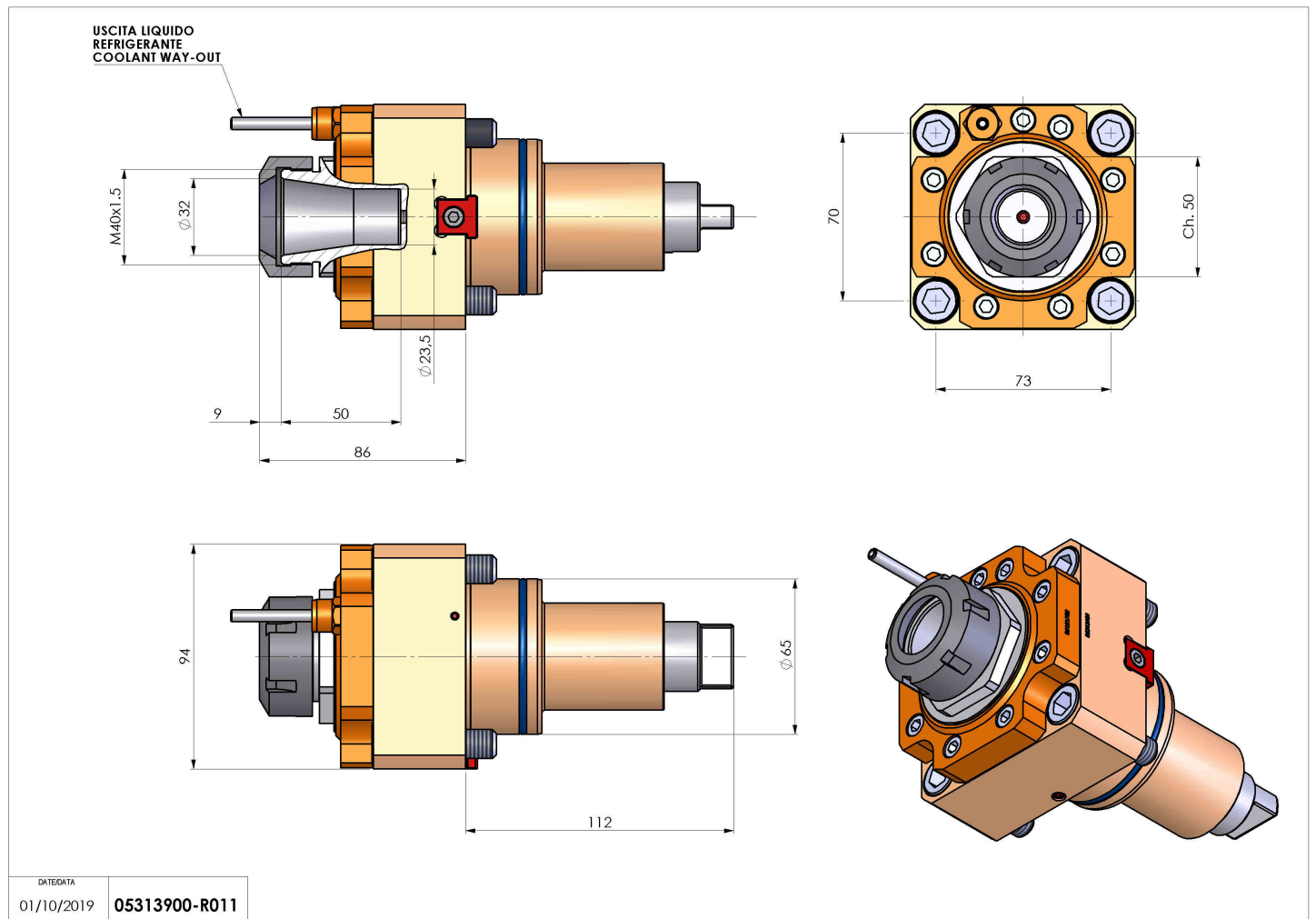

Subject to technical changes