

05311000 - LT-S BMT55 BD ER25F RF H58

Type	LT-S Tool holder straight
Mounting	BMT 55 BIG DRIVE
Tool output	Collet nut ER 25 F - internal nut
Coolant	Internal coolant
Direction of rotation	r1 r2
Max speed [rpm]	6000
Max torque [Nm]	60
Ratio	1:1
H [mm]	58
Accessories	N.A.
Notes	N.A.
Mounting tips	Not suitable for every application, please check

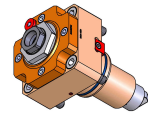

Always check live tool dimensions on the turret

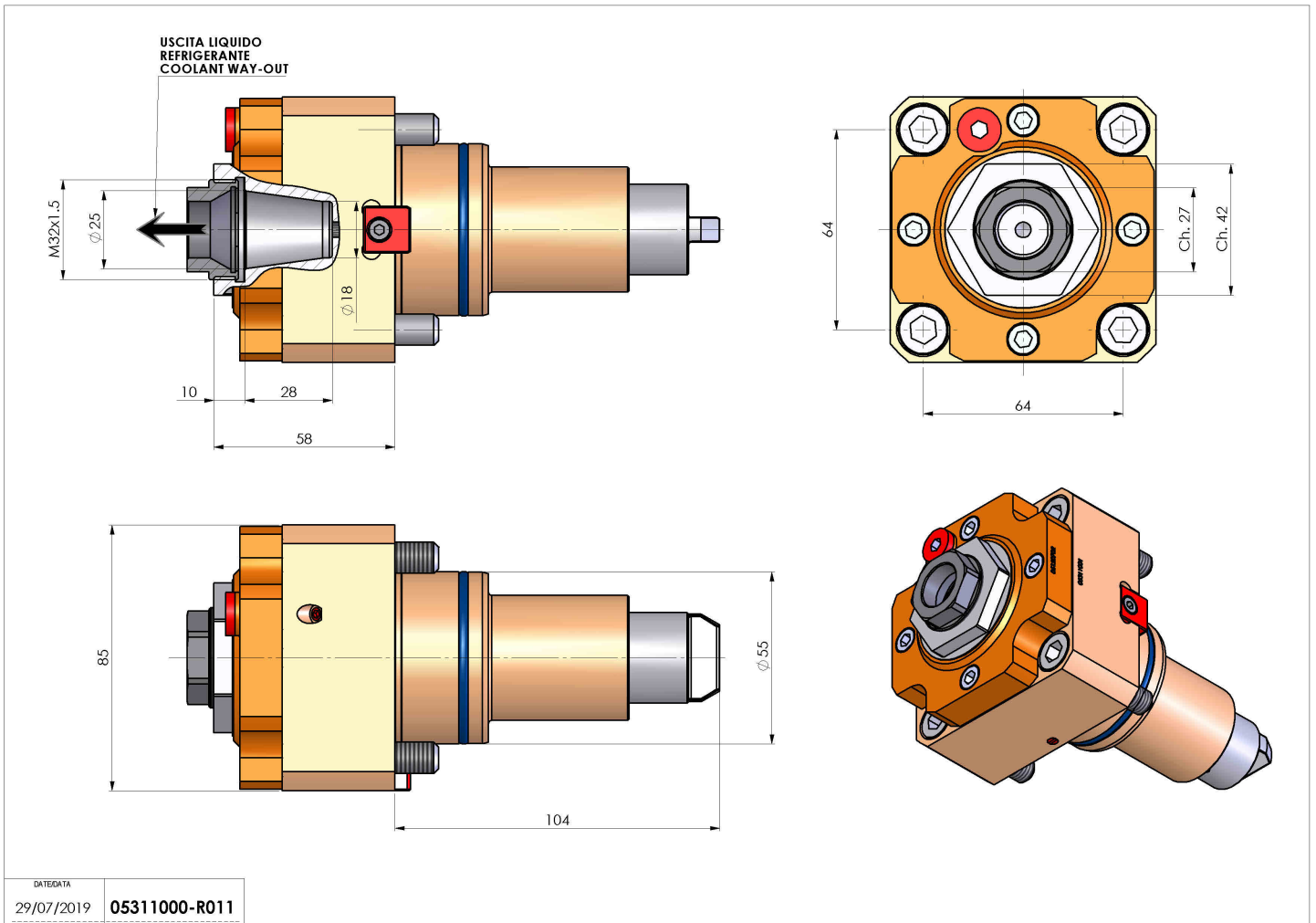

DATE/DATE	
29/07/2019	05311000-R011

Subject to technical changes