

05305000 - LT-A BMT75 ER50 LR RF 2:1 H90

Type	LT-A Tool holder angle 90°
Mounting	BMT 75
Tool output	Collet nut ER 50
Coolant	Internal coolant
Direction of rotation	r1 ↻ r2 ↻
Max speed [rpm]	in 4000 / out 2000
Max torque [Nm]	in 60 / out 120
Ratio	2:1
H [mm]	90
H1 [mm]	52
Accessories	N.A.
Notes	N.A.
Mounting tips	Not suitable for every application, please check

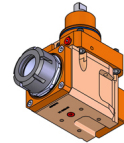

Always check live tool dimensions on the turret

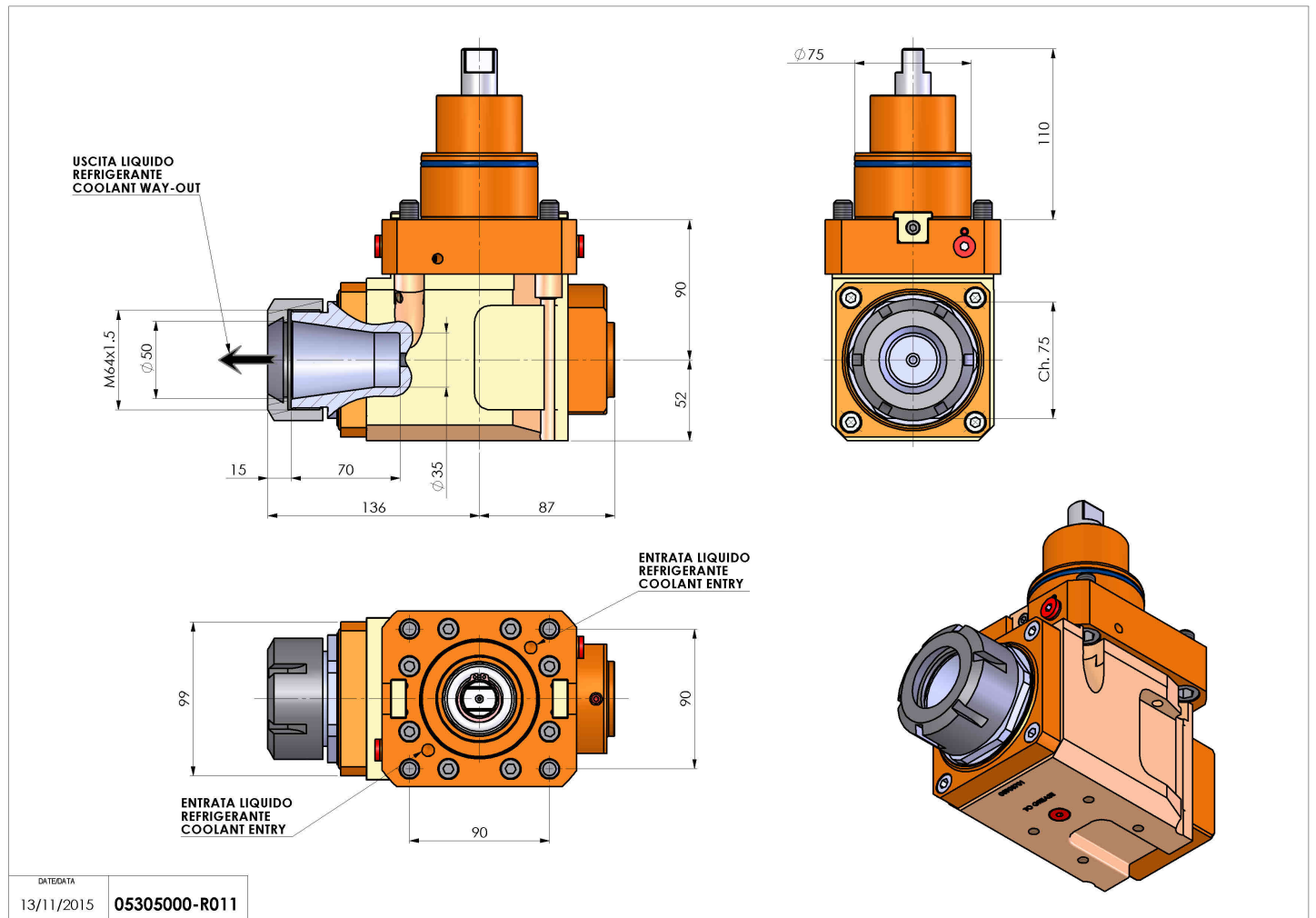

Subject to technical changes