

05292400 - LT-S D32 WELDON25 RF H70

Type	LT-S Tool holder straight
Mounting	CYLINDRICAL SHANK 32
Tool output	Weldon 25 DIN1835B
Coolant	Internal coolant
Direction of rotation	r1 r2
Max speed [rpm]	6000
Max torque [Nm]	70
Ratio	1:1
H [mm]	70
Accessories	N.A.
Notes	N.A.
Mounting tips	Not suitable for every application, please check

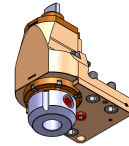

Always check live tool dimensions on the turret

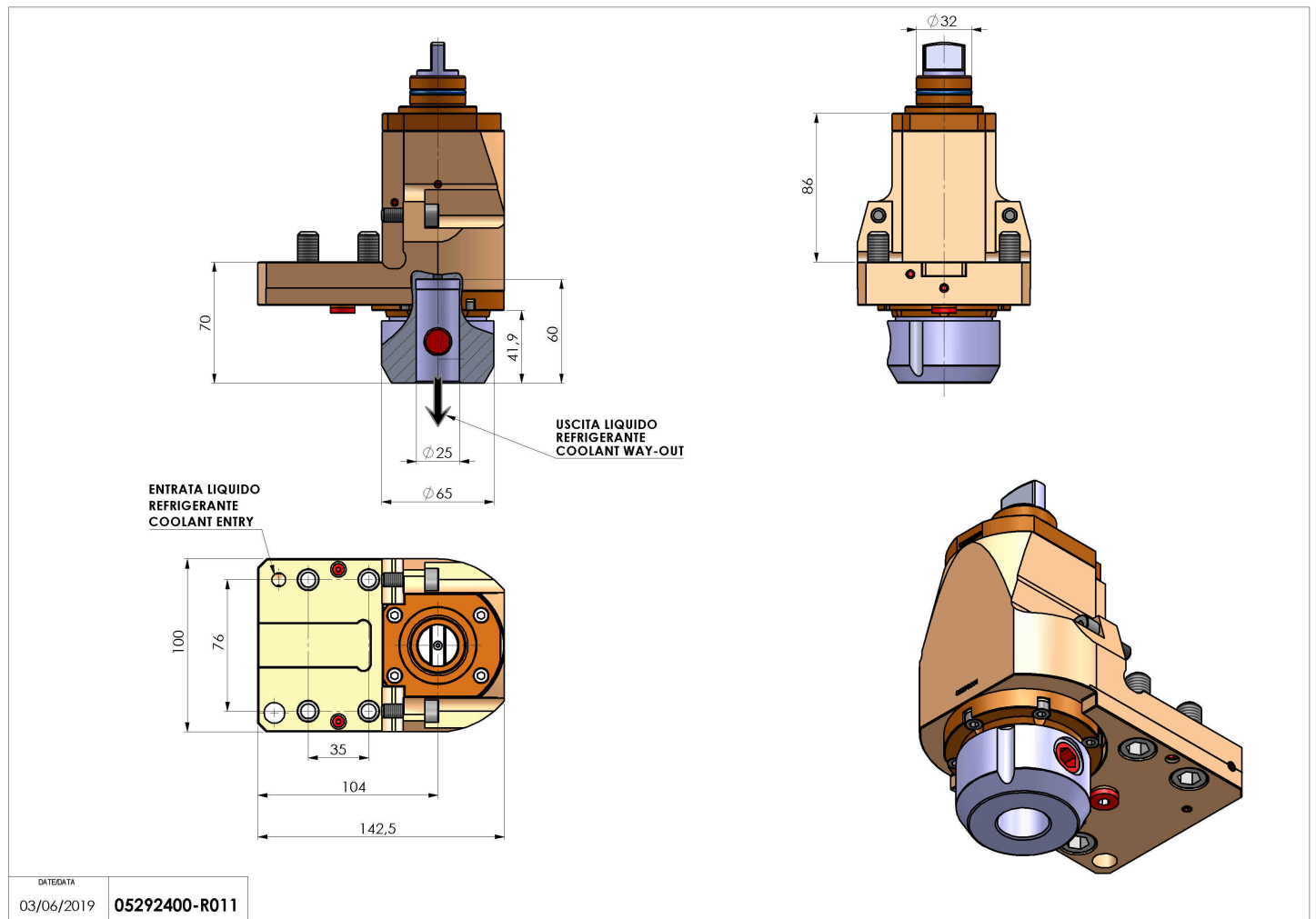

DATE/DATE	
03/06/2019	05292400-R011

Subject to technical changes