

## 05281000 - LT-A D54 ER25 H75

Type	LT-A Tool holder angle 90°
Mounting	CYLINDRICAL SHANK 54
Tool output	Collet nut ER 25
Coolant	External coolant
Direction of rotation	r1 ↻ r2 ↻
Max speed [rpm]	6000
Max torque [Nm]	40
Ratio	1:1
H [mm]	75
H1 [mm]	32,5
Accessories	N.A.
Notes	N.A.
Mounting tips	Not suitable for every application, please check

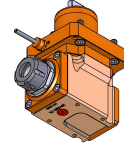

Always check live tool dimensions on the turret

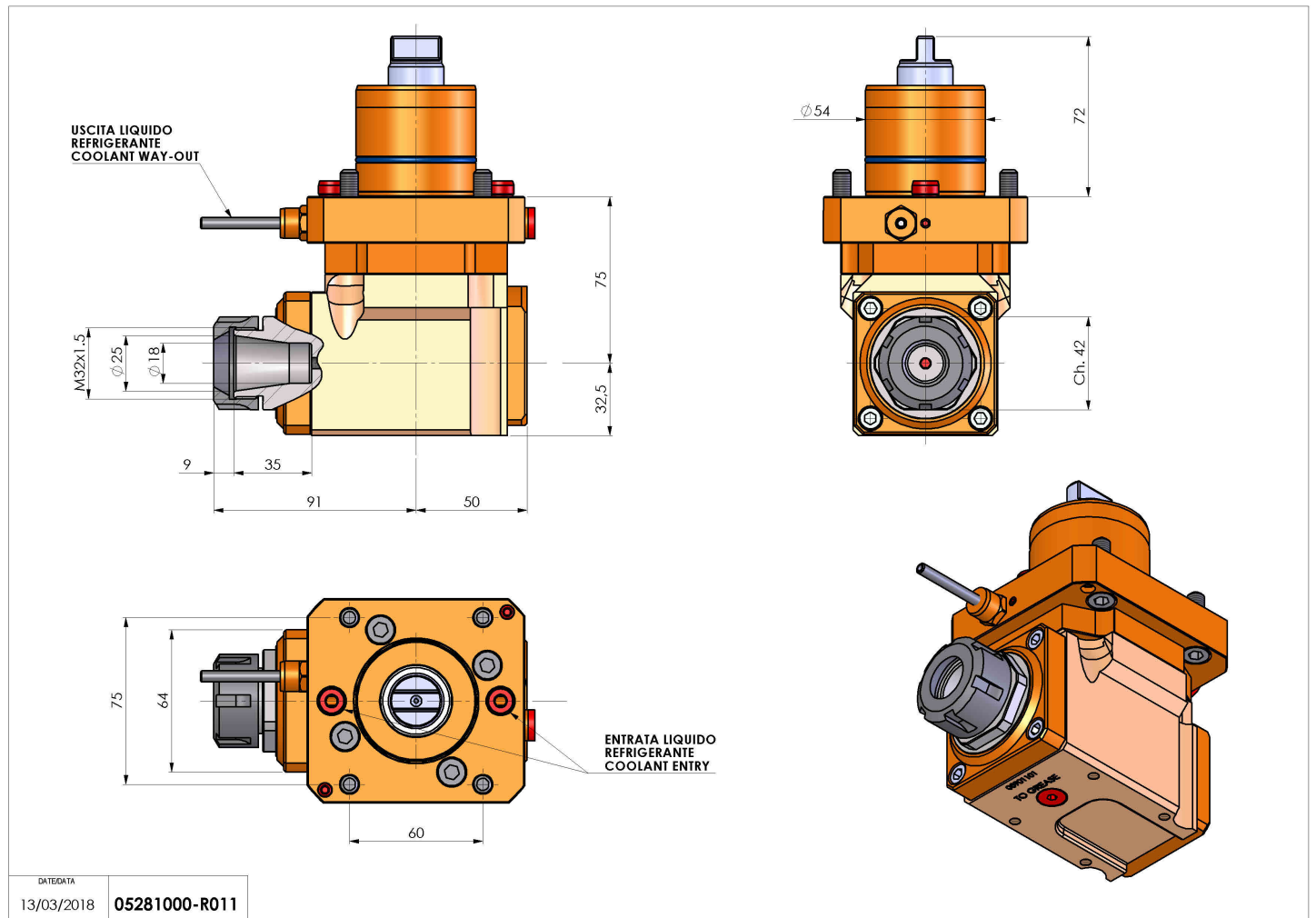

DATE/DATE  
13/03/2018 05281000-R011

Subject to technical changes