

05249000 - LT-S D75 ER40F H85

Type	LT-S Tool holder straight
Mounting	CYLINDRICAL SHANK 75
Tool output	Collet nut ER 40 F - internal nut
Coolant	External coolant
Direction of rotation	r1 ↻ r2 ↻
Max speed [rpm]	4000
Max torque [Nm]	80
Ratio	1:1
H [mm]	85
Accessories	N.A.
Notes	N.A.
Mounting tips	Not suitable for every application, please check

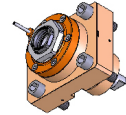

Always check live tool dimensions on the turret

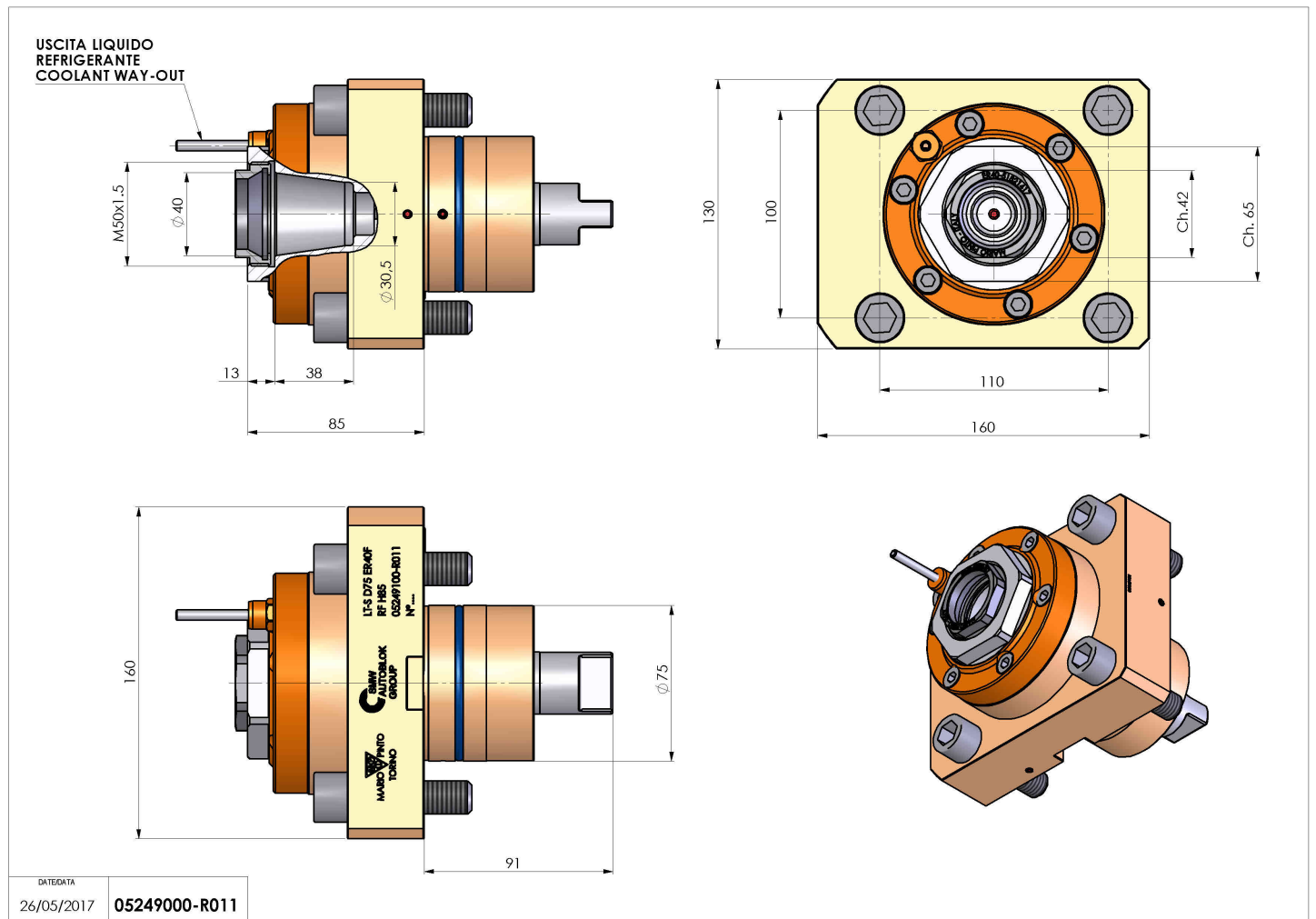

Subject to technical changes