

05245100 - LT-S D40 ER32 HS H87

Type	LT-S Tool holder straight
Mounting	CYLINDRICAL SHANK 40
Tool output	Collet nut ER 32
Coolant	External coolant
Direction of rotation	r1 ↻ r2 ↻
Max speed [rpm]	12000
Max torque [Nm]	40
Ratio	1:1
H [mm]	87,5
Accessories	
Notes	N.A.
Mounting tips	Not suitable for every application, please check

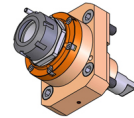

Always check live tool dimensions on the turret

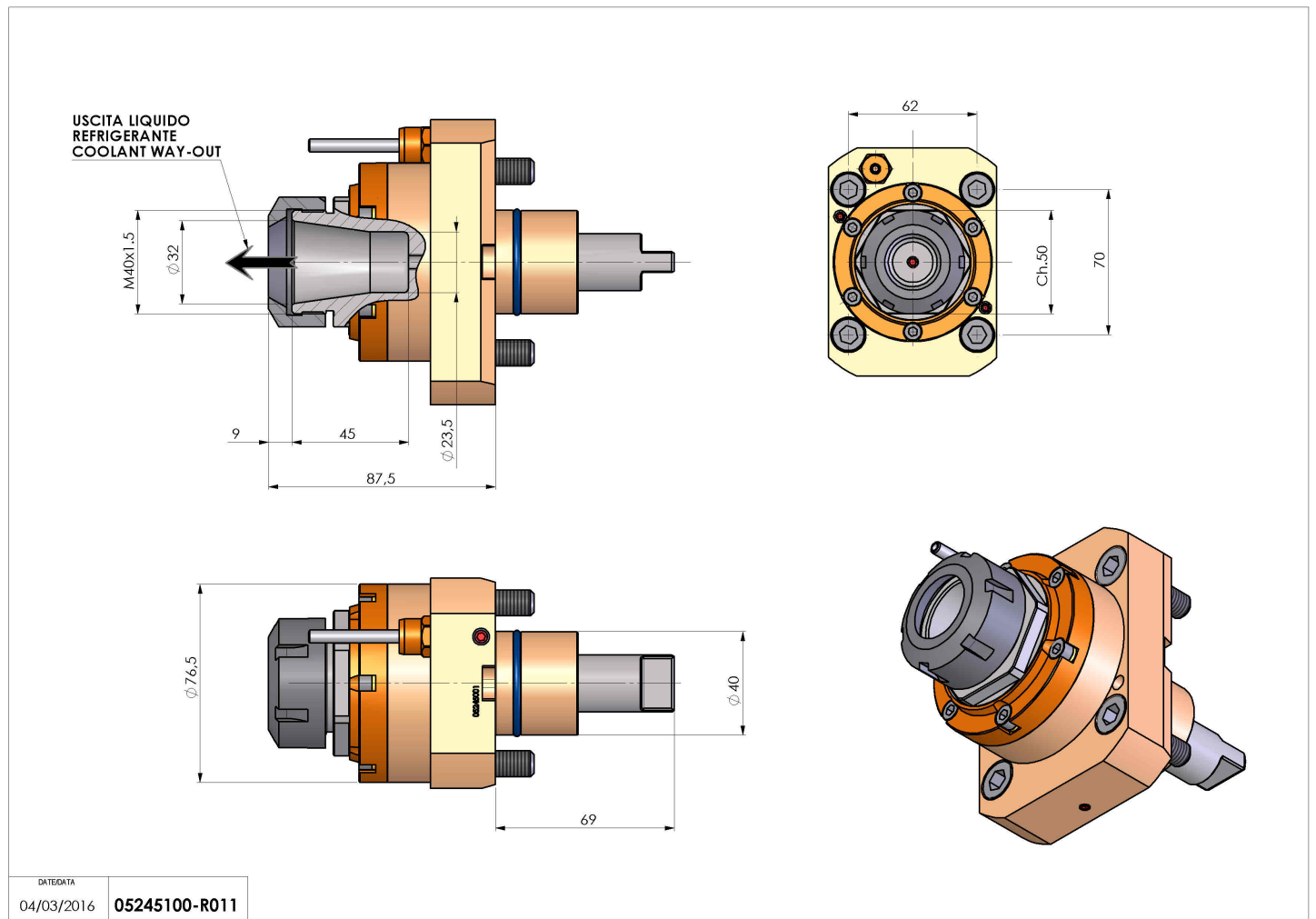

DATE/DATE
04/03/2016 05245100-R011

Subject to technical changes