



05243300 - LT-S D60 WELDON-25 RF HS H119

Type	LT-S Tool holder straight
Mounting	CYLINDRICAL SHANK 60
Tool output	Weldon 25 DIN1835B
Coolant	Internal coolant
Direction of rotation	r1  r2 
Max speed [rpm]	10000
Max torque [Nm]	63
Ratio	1:1
H [mm]	119
Accessories	N.A.
Notes	N.A.
Mounting tips	Not suitable for every application, please check



Always check live tool dimensions on the turret

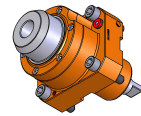
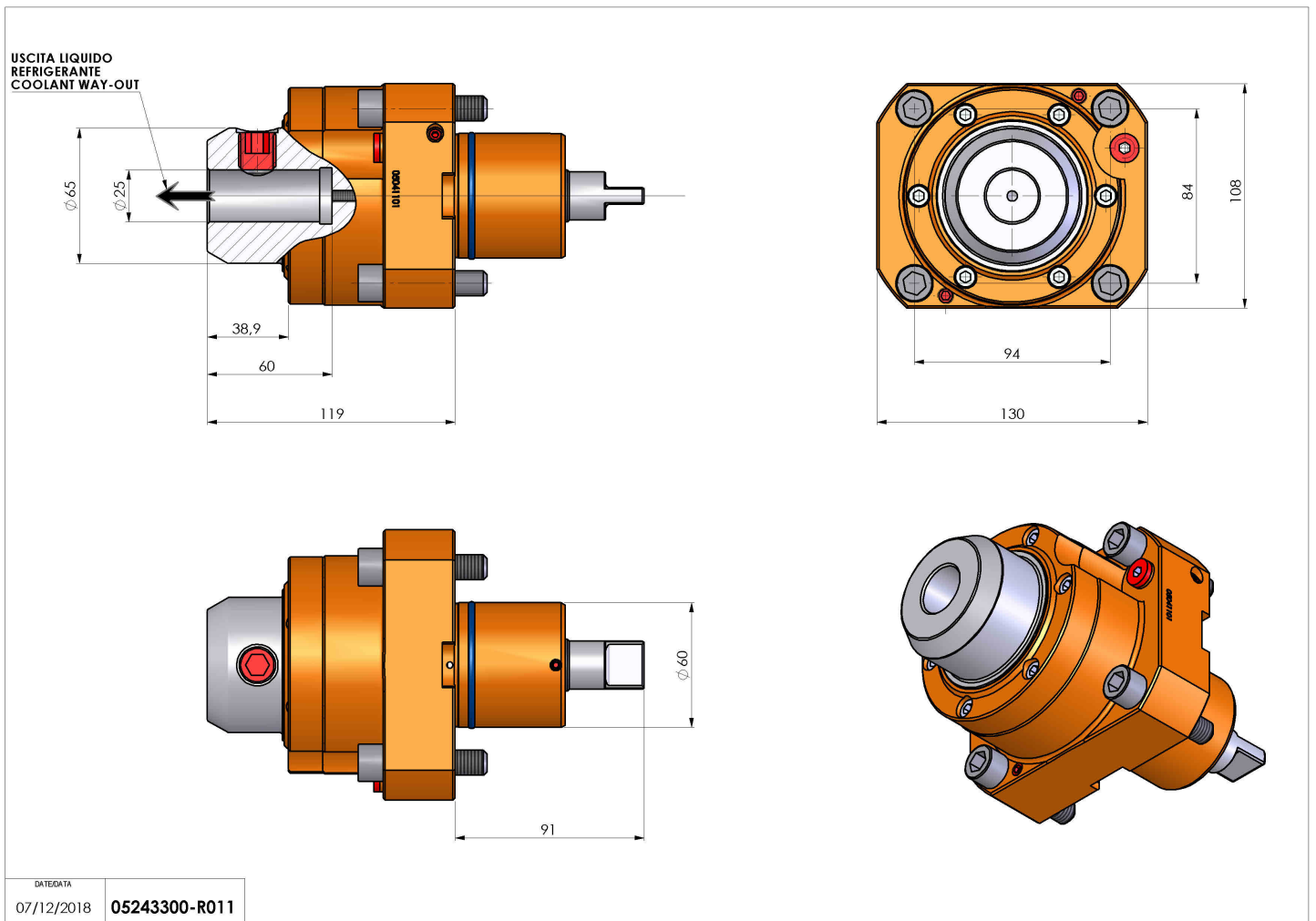

DATE/DATE
07/12/2018 05243300-R011

Subject to technical changes