

05243000 - LT-S D60 ER32F RF HS H90

Type	LT-S Tool holder straight
Mounting	CYLINDRICAL SHANK 60
Tool output	Collet nut ER 32 F - internal nut
Coolant	Internal coolant
Direction of rotation	r1  r2 
Max speed [rpm]	10000
Max torque [Nm]	63
Ratio	1:1
H [mm]	90
Accessories	N.A.
Notes	N.A.
Mounting tips	Not suitable for every application, please check

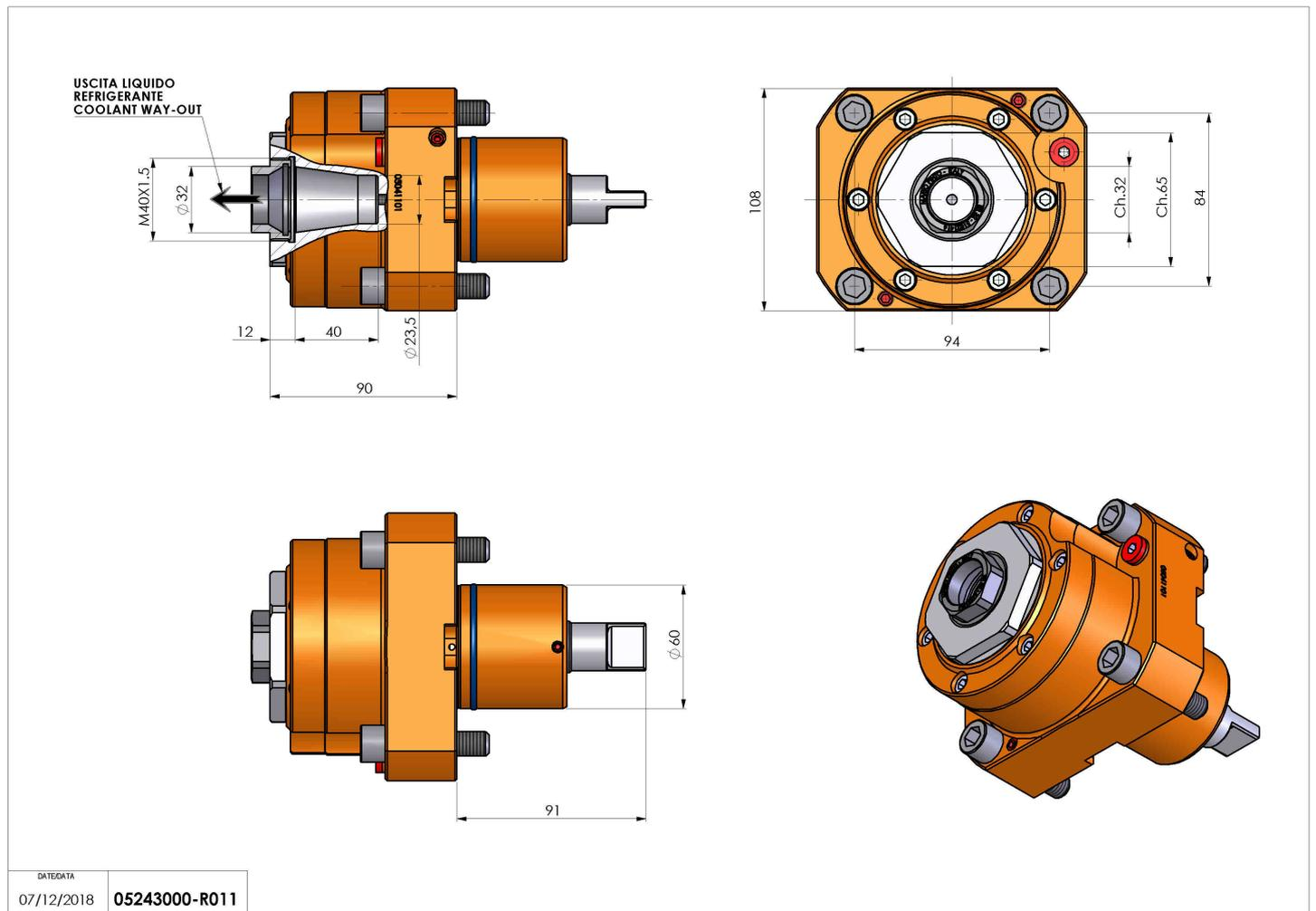

Always check live tool dimensions on the turret



DATE/DATE
07/12/2018 05243000-R011

Subject to technical changes