

05234100 - LT-S BMT75EM ER40F RF H70

Type	LT-S Tool holder straight
Mounting	BMT 75 EM
Tool output	Collet nut ER 40 F - internal nut
Coolant	Internal coolant
Direction of rotation	r1 r2
Max speed [rpm]	6000
Max torque [Nm]	100
Ratio	1:1
H [mm]	70
Accessories	N.A.
Notes	N.A.
Mounting tips	Not suitable for every application, please check

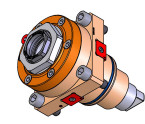

Always check live tool dimensions on the turret

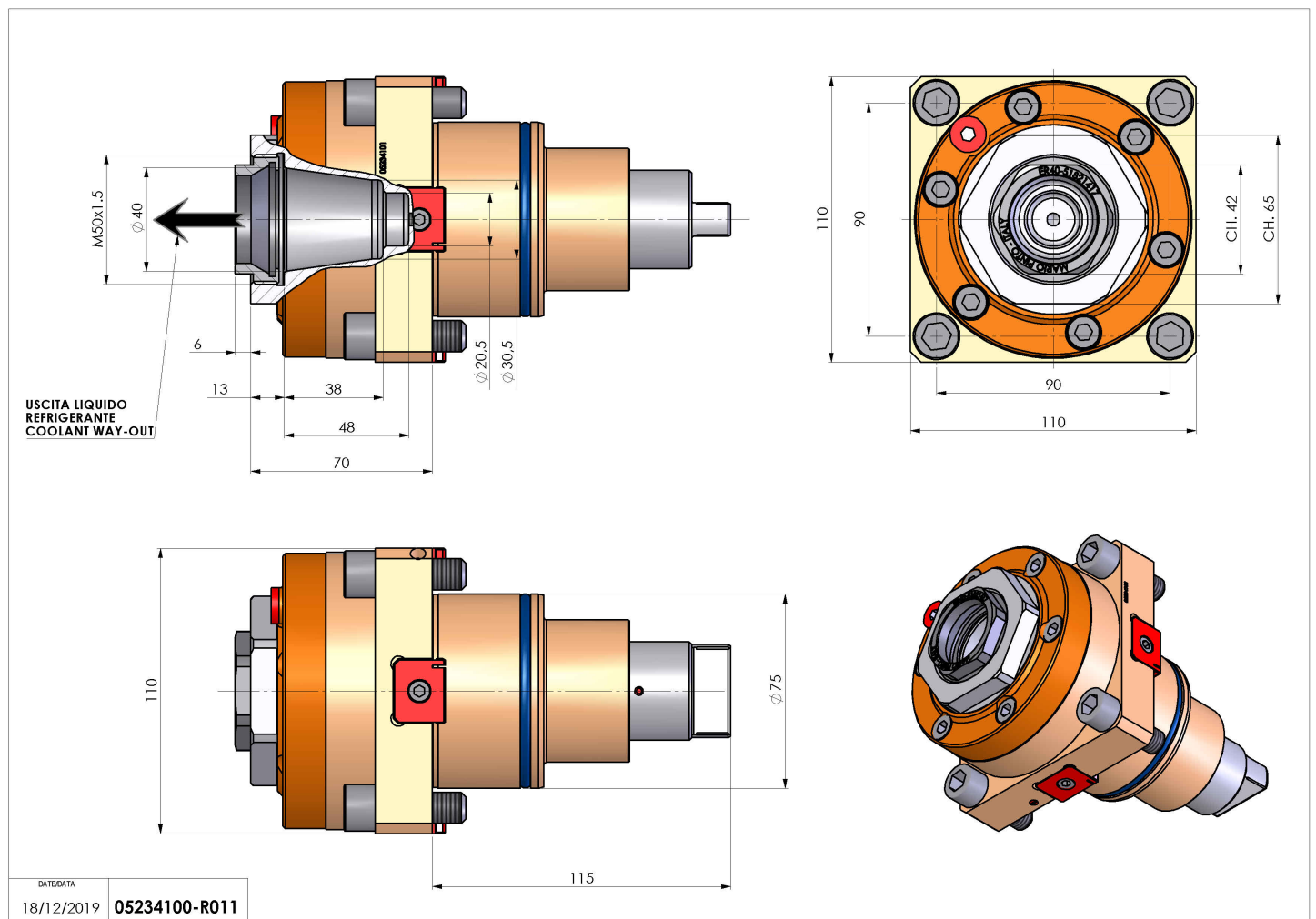

Subject to technical changes