

## 05175300 - LT-S VDI50 DIN138-27 H84 BA

<b>Type</b>	LT-S Tool holder straight
<b>Mounting</b>	VDI 50
<b>Tool output</b>	Shell-Mill DIN138 27
<b>Coolant</b>	External coolant
<b>Direction of rotation</b>	r1  r2
<b>Max speed [rpm]</b>	6000
<b>Max torque [Nm]</b>	120
<b>Ratio</b>	1:1
<b>H [mm]</b>	84
<b>Accessories</b>	
<b>Notes</b>	N.A.
<b>Mounting tips</b>	Not suitable for every application, please check

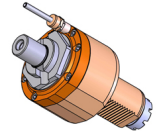

**ATTENZIONE: VERIFICARE L'ORIENTAMENTO DELLA DENTATURA VDI**

Always check live tool dimensions on the turret

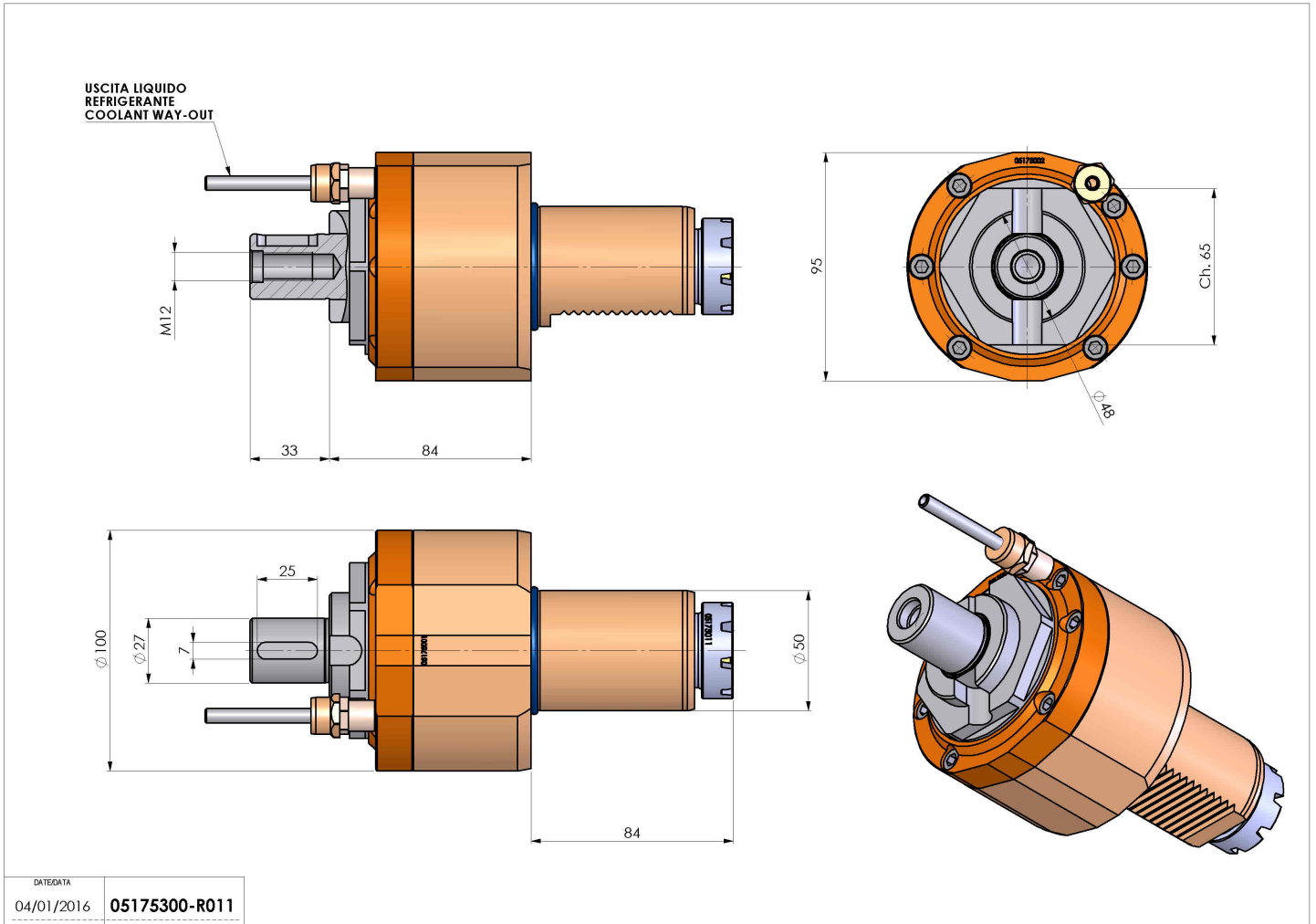

Subject to technical changes