

05174400 - LT-A VDI30 ER25F LR RF H105 BA

Type	LT-A Tool holder angle 90°
Mounting	VDI 30
Tool output	Collet nut ER 25 F - internal nut
Coolant	Internal coolant
Direction of rotation	r1 ↻ r2 ↻
Max speed [rpm]	6000
Max torque [Nm]	30
Ratio	1:1
H [mm]	105
H1 [mm]	32,5
Accessories	N.A.
Notes	N.A.
Mounting tips	Not suitable for every application, please check

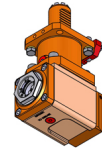

ATTENZIONE: VERIFICARE L'ORIENTAMENTO DELLA DENTATURA VDI

Always check live tool dimensions on the turret

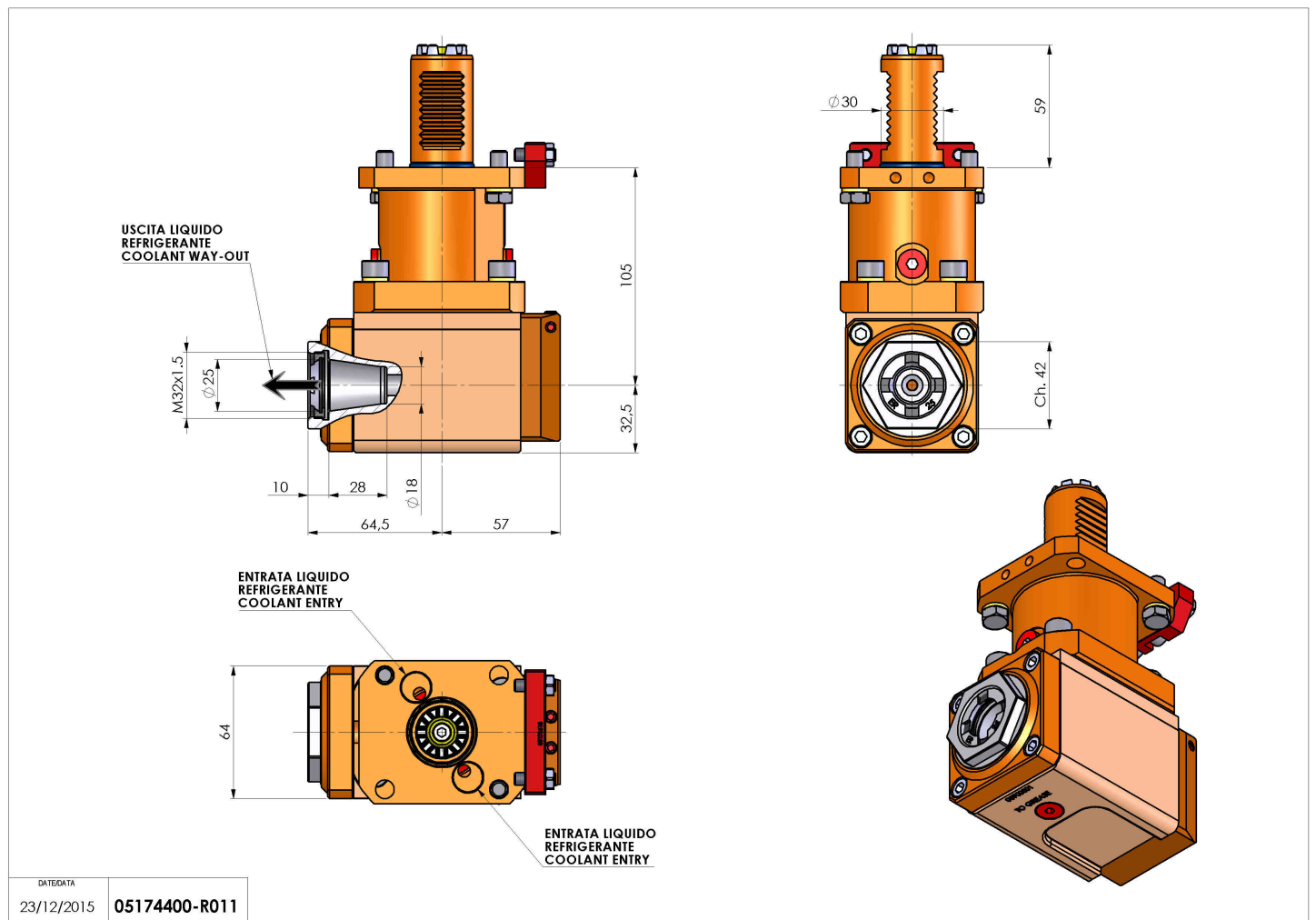

DATE/DATE	23/12/2015	05174400-R011
-----------	------------	---------------

Subject to technical changes