



05172400 - LT-S VDI40 DIN138-22 H81 BA

Type	LT-S Tool holder straight
Mounting	VDI 40
Tool output	Shell-Mill DIN138 22
Coolant	External coolant
Direction of rotation	r1  r2 
Max speed [rpm]	6000
Max torque [Nm]	63
Ratio	1:1
H [mm]	81
Accessories	
Notes	N.A.
Mounting tips	Not suitable for every application, please check

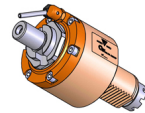

ATTENZIONE: VERIFICARE L'ORIENTAMENTO DELLA DENTATURA VDI

Always check live tool dimensions on the turret

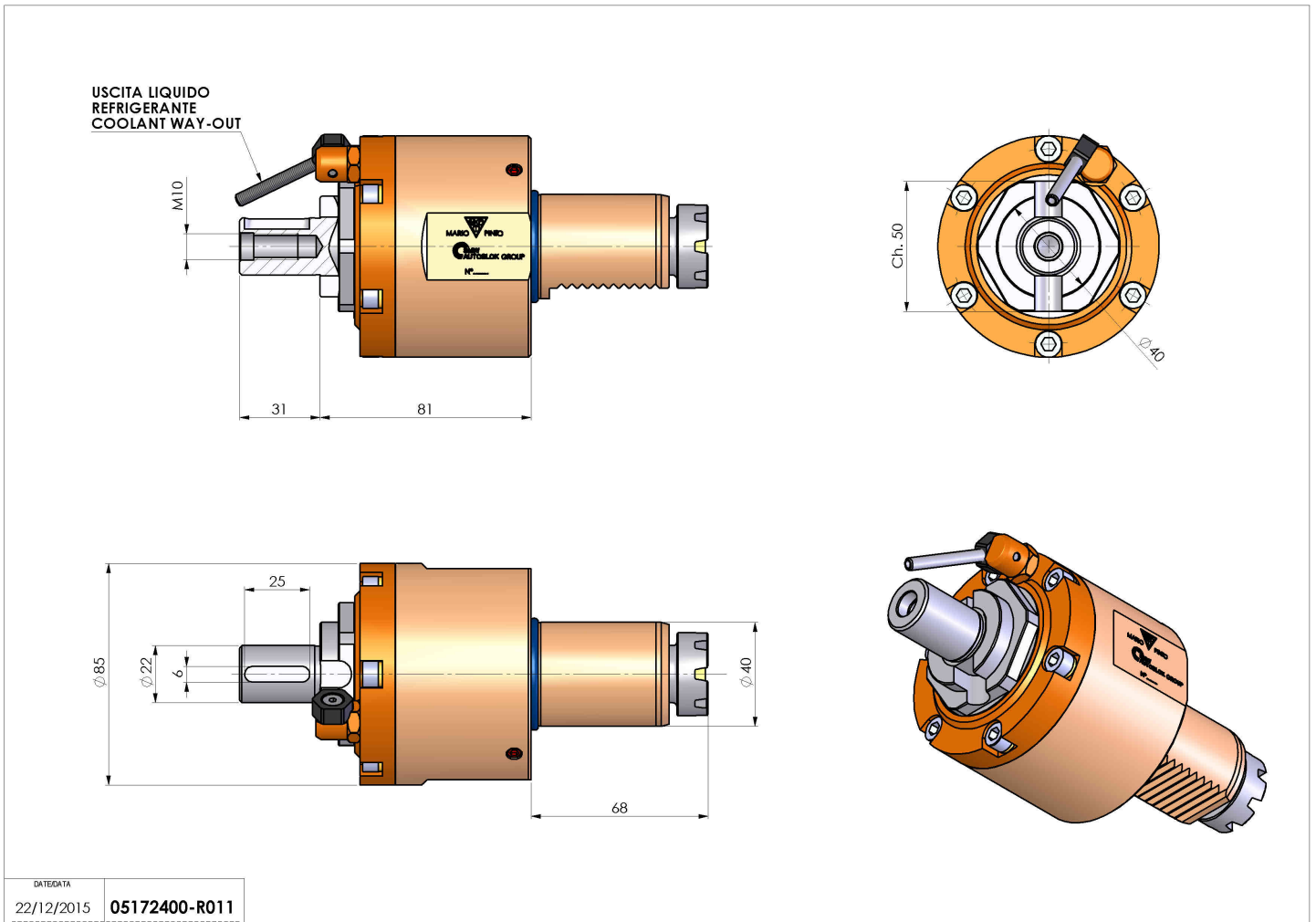

Subject to technical changes