

05168200 - LT-S D40 C40 HRF H86

Type	LT-S Tool holder straight
Mounting	CYLINDRICAL SHANK 40
Tool output	Polygonal shank C40 ISO 26623-1
Coolant	HP Internal coolant
Direction of rotation	r1 r2
Max speed [rpm]	6000
Max torque [Nm]	40
Ratio	1:1
H [mm]	86
Max pressure [bar]	70
Accessories	N.A.
Notes	N.A.
Mounting tips	Not suitable for every application, please check

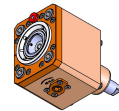

Always check live tool dimensions on the turret

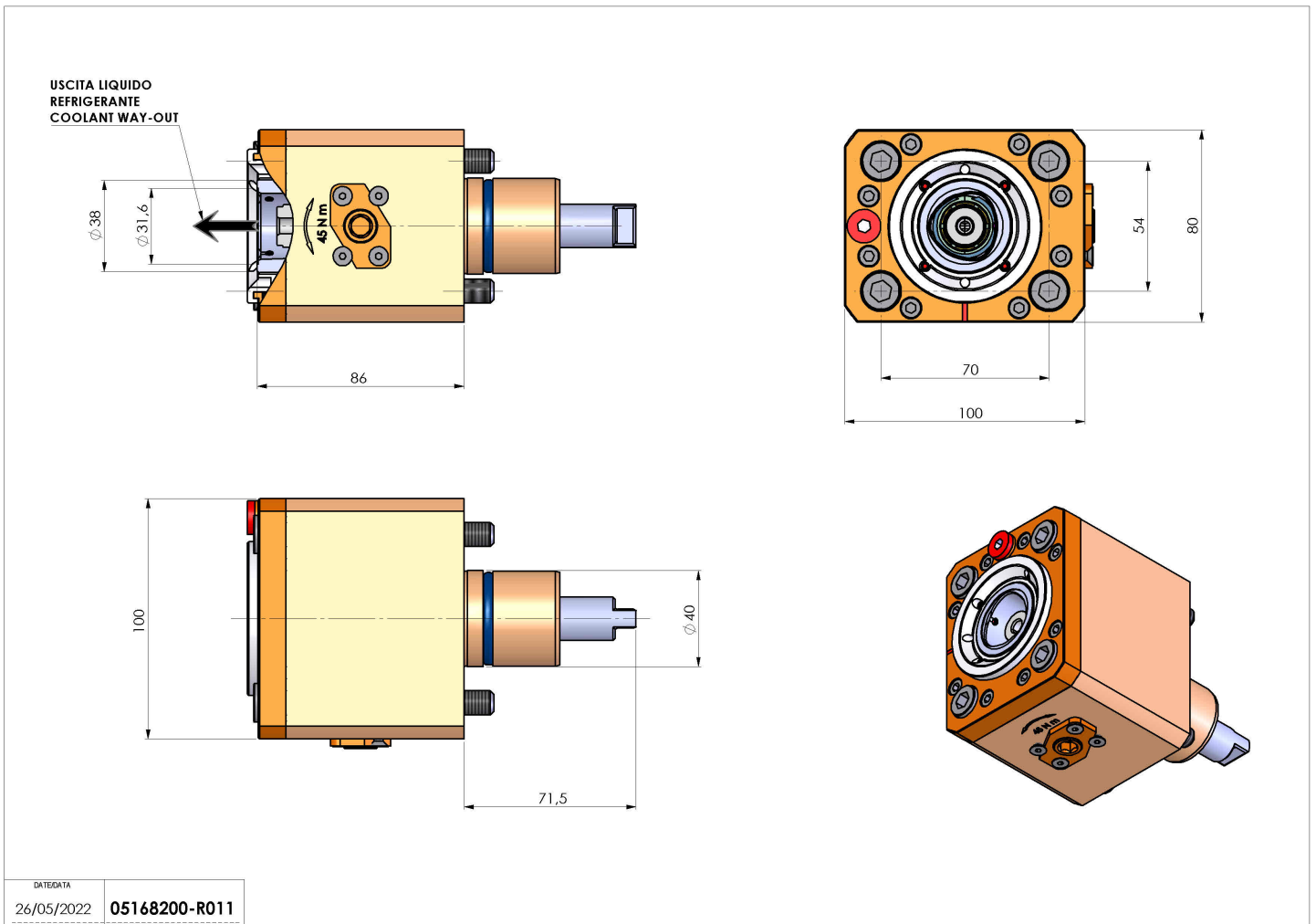

Subject to technical changes