

05159400 - LT-S D40 DIN138-16 OFS90H100MU

Type	LT-S OFS Tool holder straight offset
Mounting	CYLINDRICAL SHANK 40
Tool output	Shell-Mill DIN138 16
Coolant	External coolant
Offset [mm]	90
Direction of rotation	r1 ↻ r2 ↻
Max speed [rpm]	6000
Max torque [Nm]	25
Ratio	1:1
H [mm]	100
Accessories	N.A.
Notes	N.A.
Mounting tips	Not suitable for every application, please check

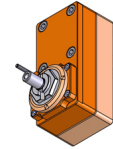

Always check live tool dimensions on the turret

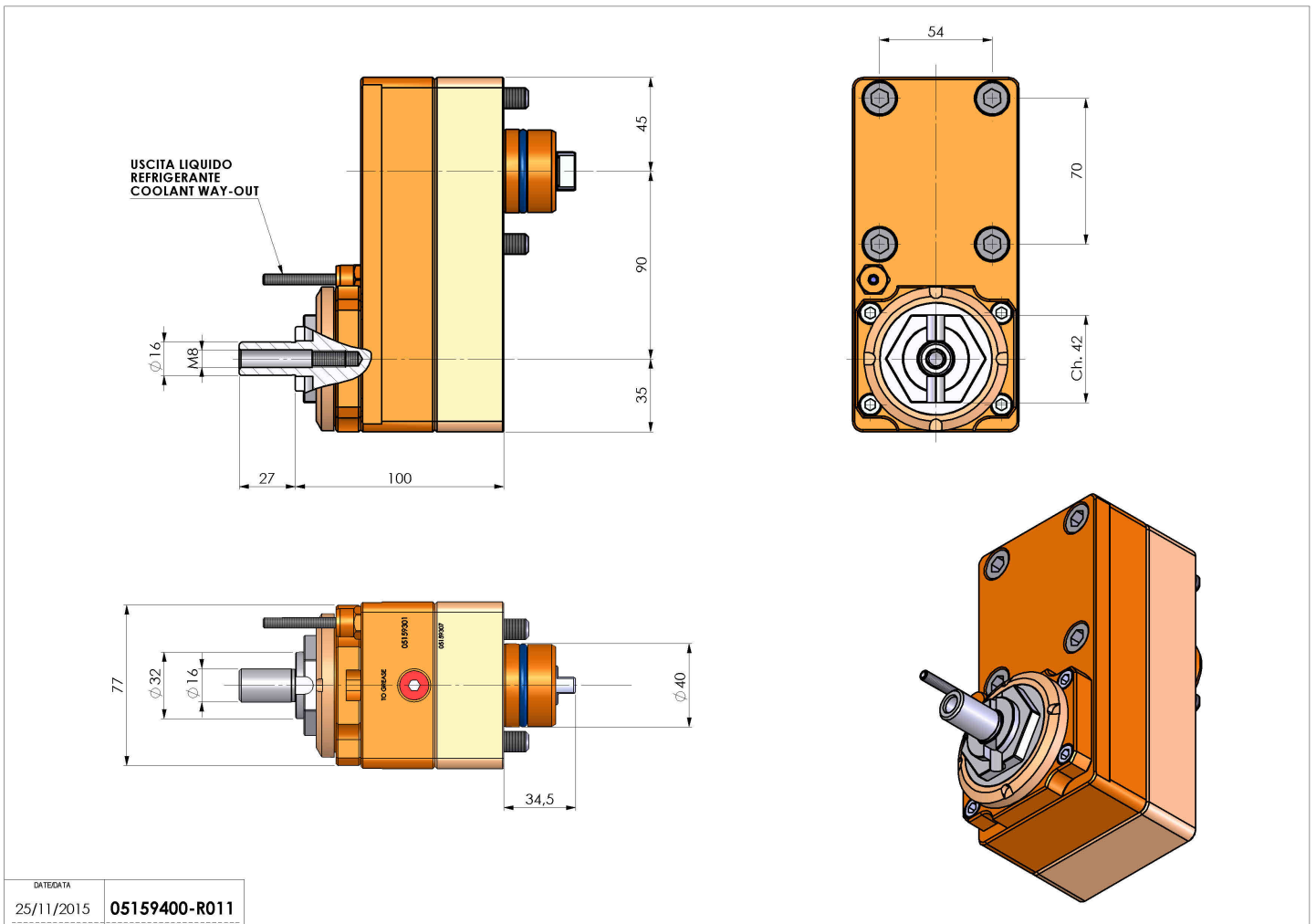

Subject to technical changes