

05062500 - LT-S D60 ER32F HRF H73

Type	LT-S Tool holder straight
Mounting	CYLINDRICAL SHANK 60
Tool output	Collet nut ER 32 F - internal nut
Coolant	HP Internal coolant
Direction of rotation	r1 r2
Max speed [rpm]	6000
Max torque [Nm]	63
Ratio	1:1
H [mm]	73
Max pressure [bar]	70
Accessories	N.A.
Notes	N.A.
Mounting tips	Not suitable for every application, please check

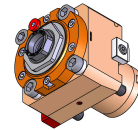

Always check live tool dimensions on the turret

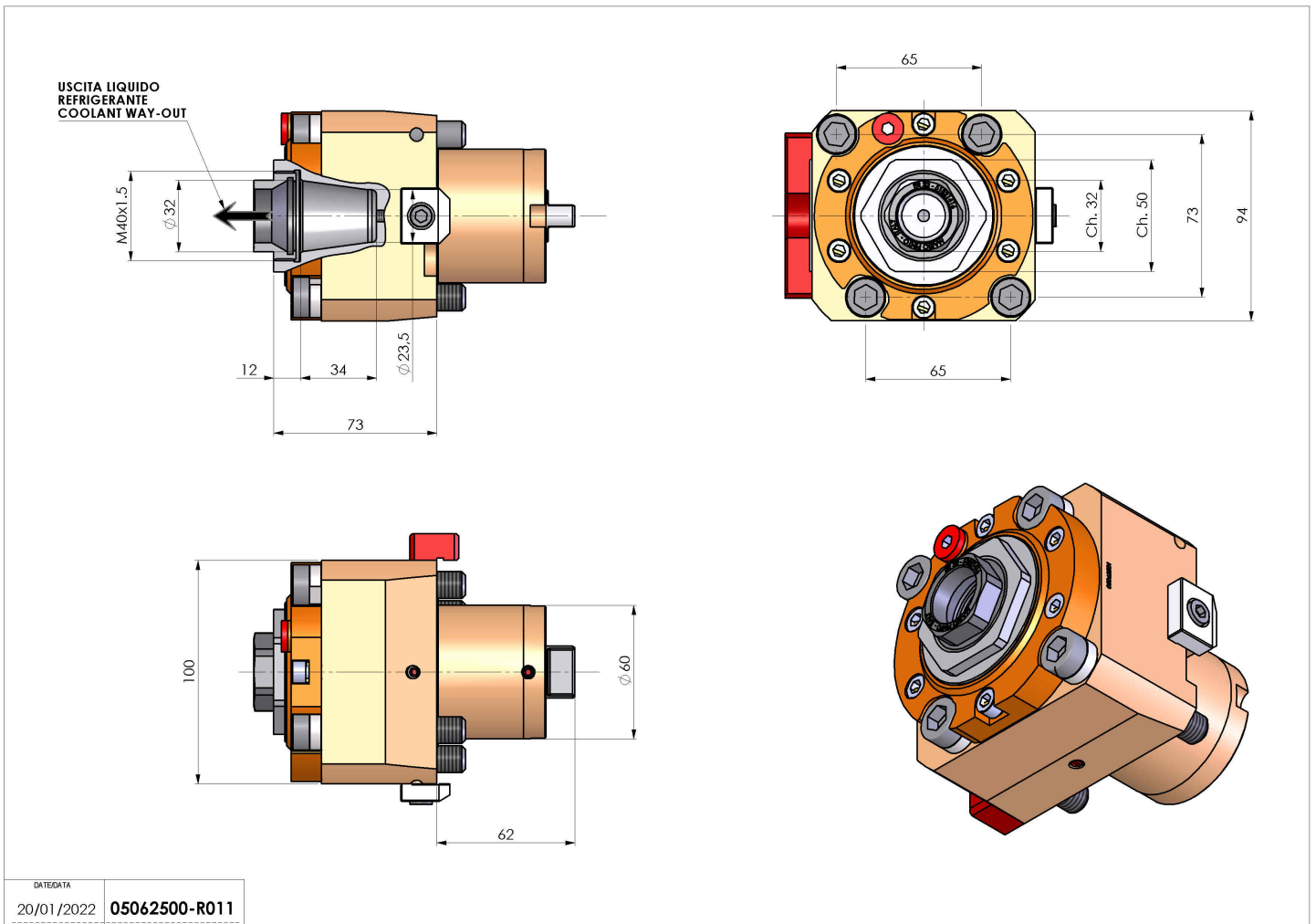

Subject to technical changes