

05051700 - LT-A VDI40 DIN138-22 L H130 MZ

Type	LT-A Tool holder angle 90°
Mounting	VDI 40
Tool output	Shell-Mill DIN138 22
Coolant	External coolant
Direction of rotation	r1 ↻ r2 ↻
Max speed [rpm]	6000
Max torque [Nm]	63
Ratio	1:1
H [mm]	130
H1 [mm]	38
Accessories	N.A.
Notes	N.A.
Mounting tips	Not suitable for every application, please check

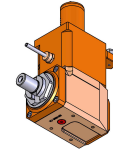

ATTENZIONE: VERIFICARE L'ORIENTAMENTO DELLA DENTATURA VDI

Always check live tool dimensions on the turret

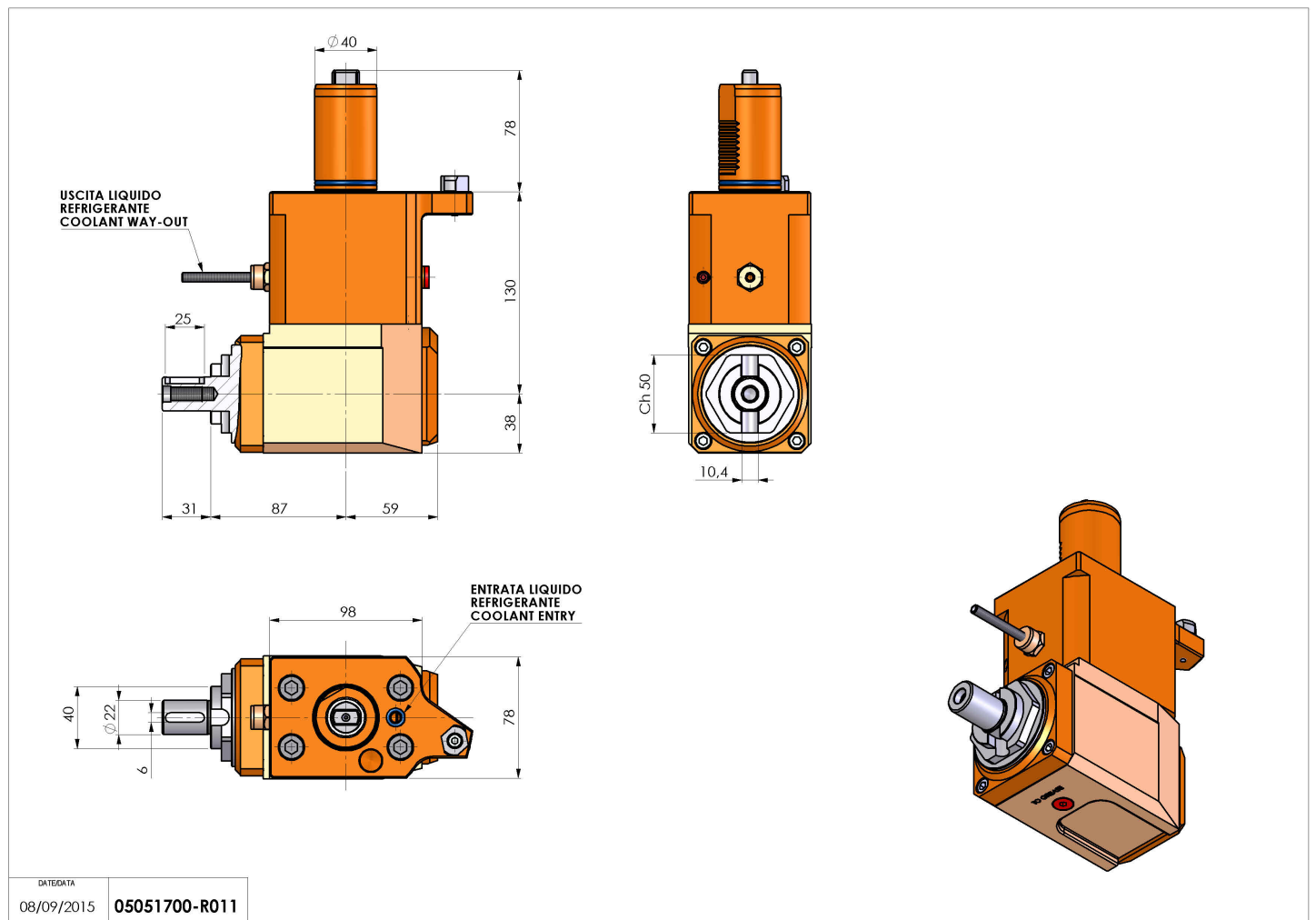

DATE/DATE
08/09/2015 05051700-R011

Subject to technical changes