

05051300 - LT-S VDI40 DIN22 OFS50 H100 MZ

Type	LT-S OFS Tool holder straight offset
Mounting	VDI 40
Tool output	Shell-Mill DIN138 22
Coolant	External coolant
Offset [mm]	50
Direction of rotation	r1 ↻ r2 ↻
Max speed [rpm]	6000
Max torque [Nm]	63
Ratio	1:1
H [mm]	100
Accessories	N.A.
Notes	N.A.
Mounting tips	Not suitable for every application, please check

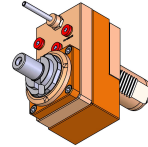

ATTENZIONE: VERIFICARE L'ORIENTAMENTO DELLA DENTATURA VDI

Always check live tool dimensions on the turret

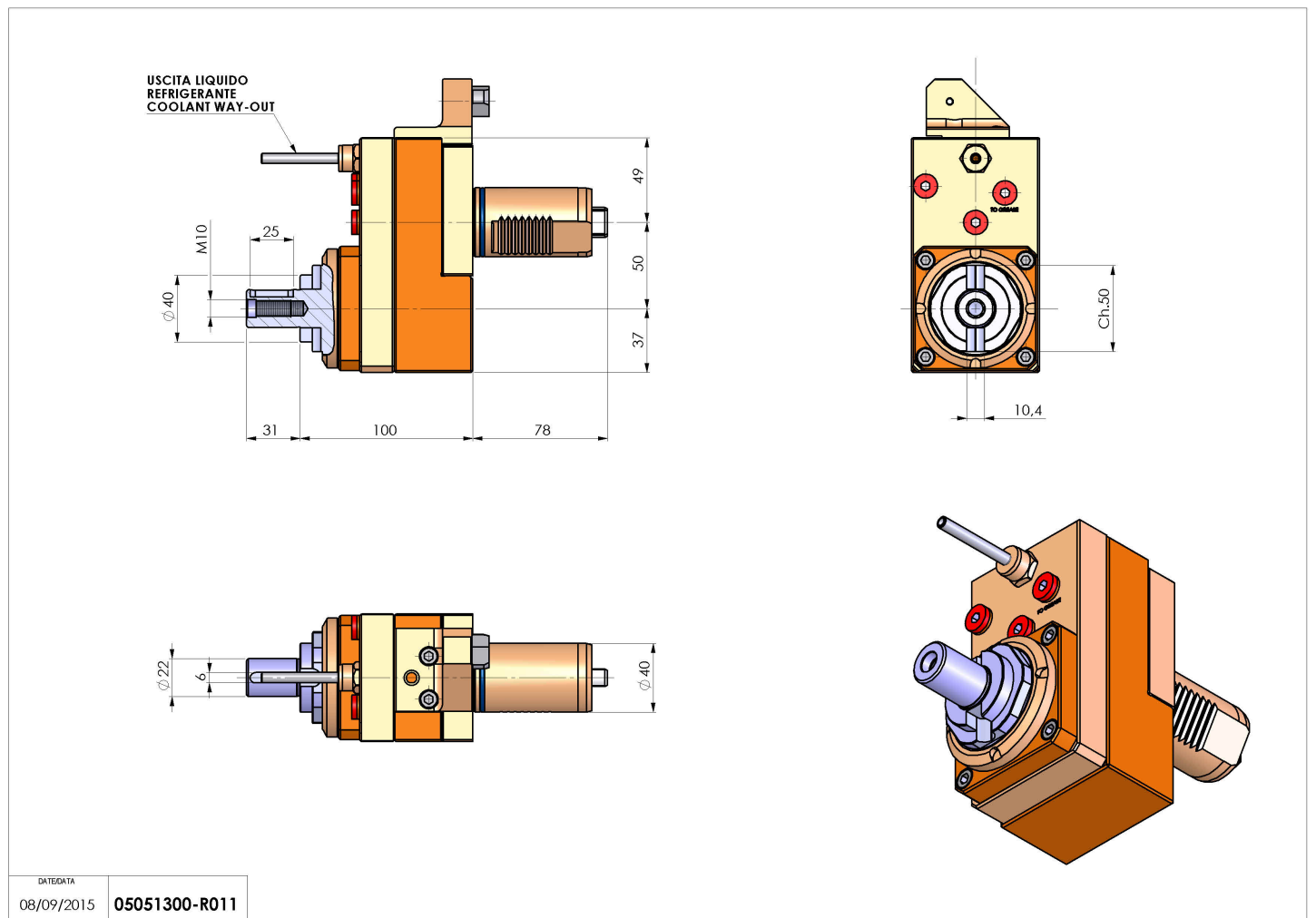

DATE/DATE	08/09/2015
	05051300-R011

Subject to technical changes