



05042800 - LT-S D60 ER32 RF H113

Type	LT-S Tool holder straight
Mounting	CYLINDRICAL SHANK 60
Tool output	Collet nut ER 32
Coolant	Internal coolant
Direction of rotation	r1  r2 
Max speed [rpm]	6000
Max torque [Nm]	63
Ratio	1:1
H [mm]	113
Accessories	N.A.
Notes	N.A.
Mounting tips	Not suitable for every application, please check



Always check live tool dimensions on the turret

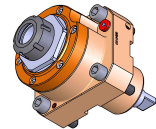
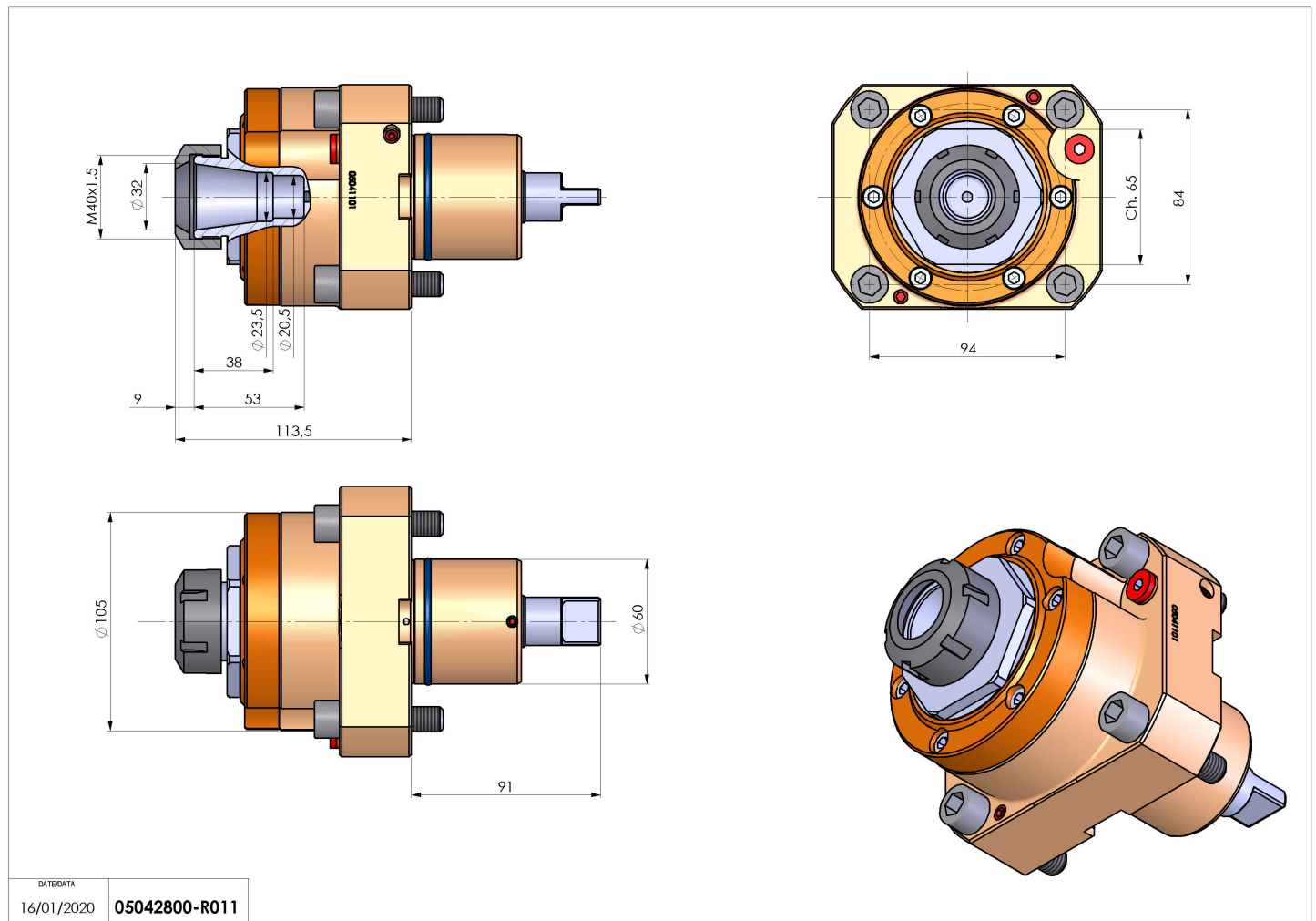

DATE/DATE
16/01/2020 05042800-R011

Subject to technical changes